

arnocanali

per portare energia

Sistemi di canalizzazione e componenti per uso industriale
Ducting systems and components for industrial use



Catalogo Kablo
Kablo Catalogue

2023

..... altre documentazioni



Listino PREZZI



Catalogo GENERALE



Catalogo GRIGLIA e Canali in Metallo



Catalogo KLIMA



Catalogo OFFICE-PLUS



Catalogo WALKABLE



Via G. Di Vittorio, 34/36
50067 - Rignano sull'Arno
Firenze - Italia
Telefono +39 055 8349181
Telefax +39 055 8349185
Sito: www.arnocanali.it
E-mail: info@arnocanali.it



Catalogo PROTECTION

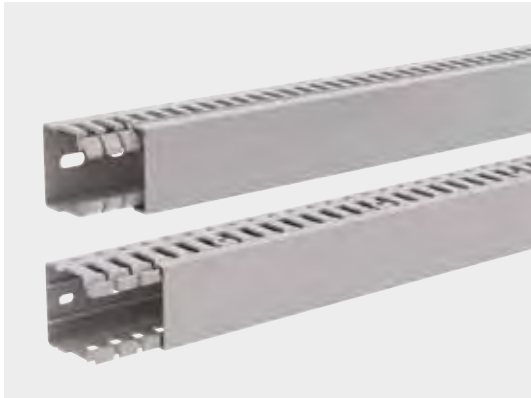

Kablo

2

Sistemi di canali e accessori per il cablaggio di quadri elettrici
Wiring trunking systems and accessories for electrical panels

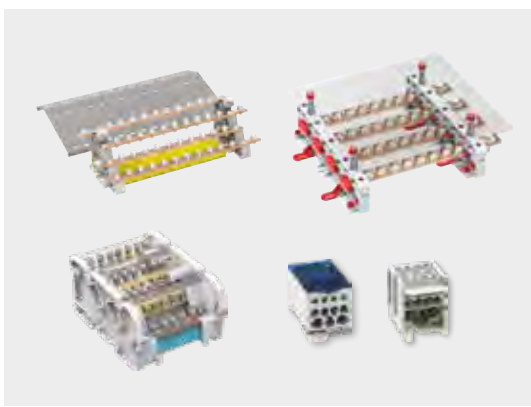

Morsettiere

18

Distribution Frames

Morsettiere di ripartizione per quadri elettrici, Ripartitori quadripolari versione a scaletta e piana, Morsetti con serraggio a vite e molla
Distribution terminal posts for panels, Quadripolar distribution frames Ladder and Flat version, screw and spring clamp terminal blocks

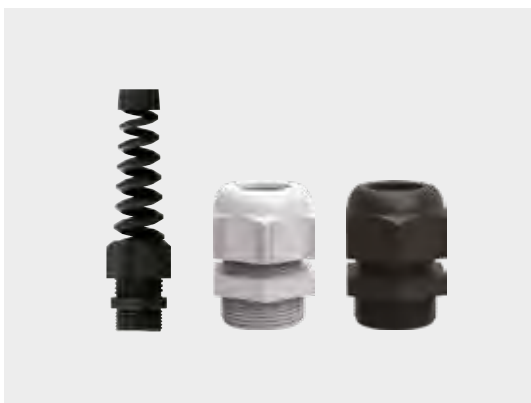

Pressacavi

52

Cable glands

Pressacavi IP68 con controdamo, tappi filettati e guarnizioni
Cable glands IP68 with locknut, Screw plugs and sealing rings

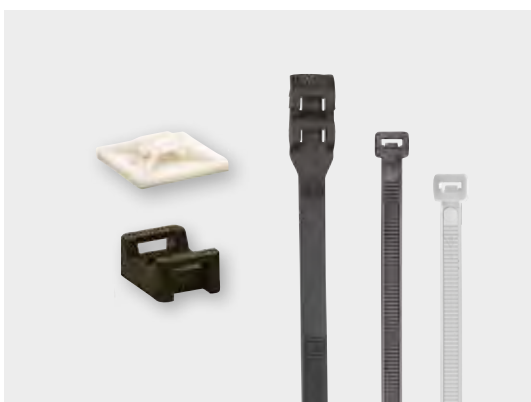

Fascette

62

Cable ties

Fascette per cablaggio, installazione, siglatura e accessori
Cable ties, installation cable ties, plate for labeling and accessories

KABLO

Sistemi di canali e accessori per il cablaggio di quadri elettrici

Wiring trunking systems and accessories for electrical panels

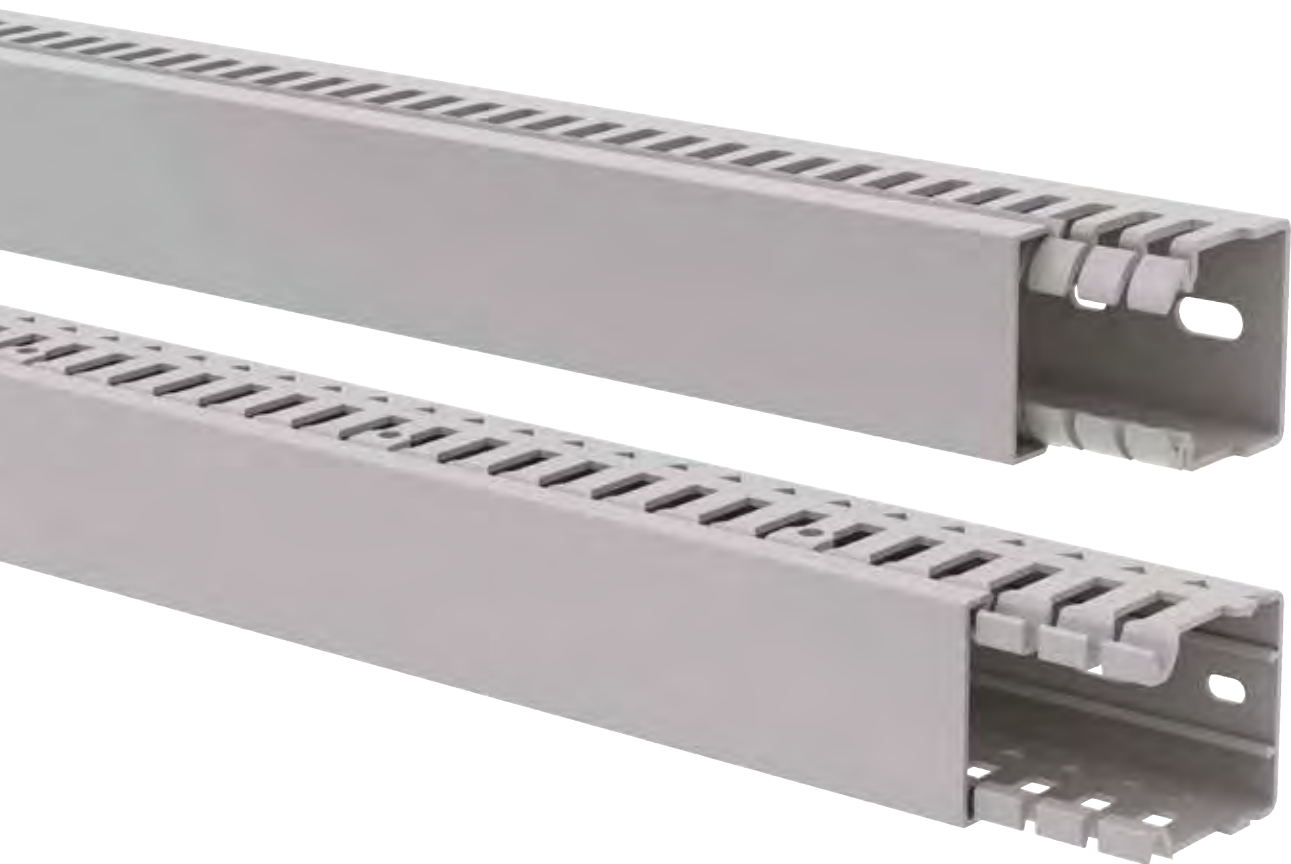

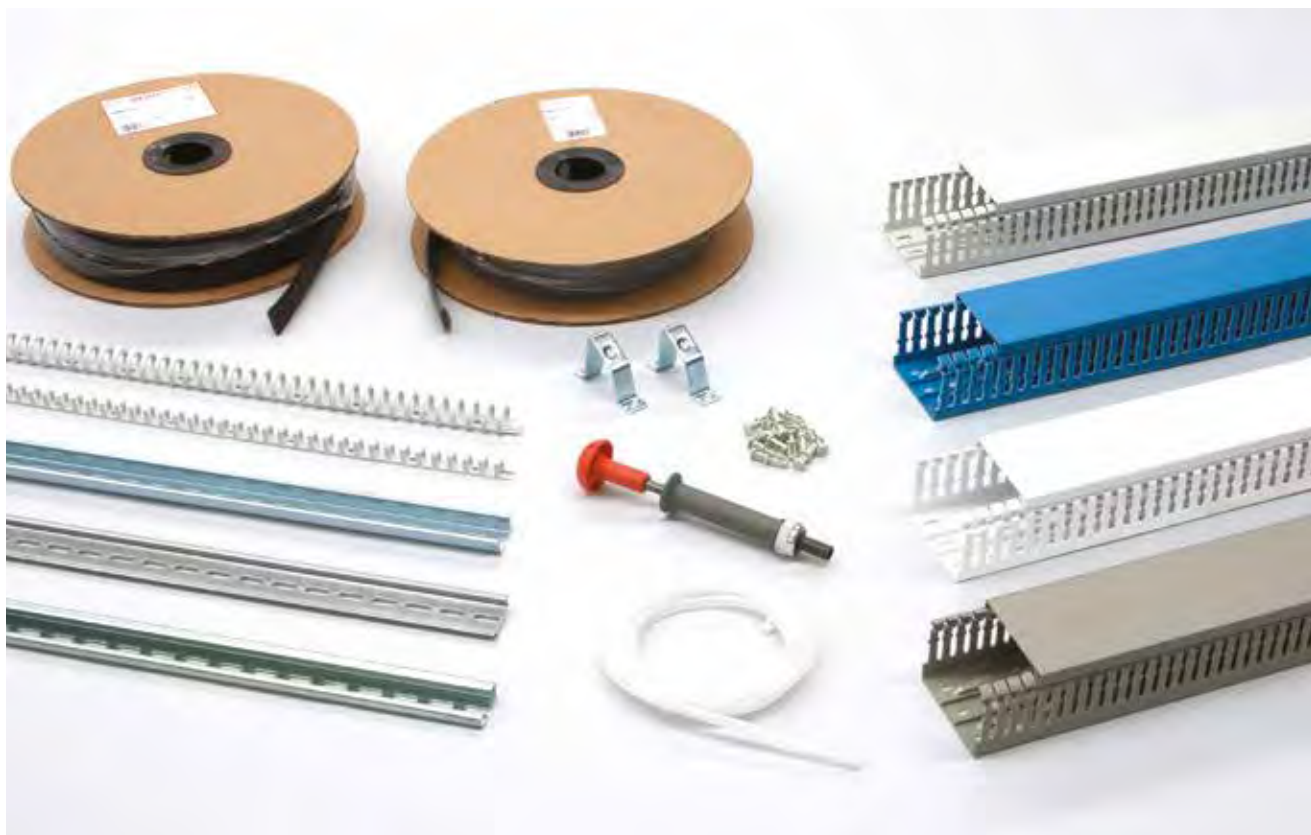

Caratteristiche Tecniche

- Canale in PVC e PC-ABS senza alogeni
- Canale lunghezza standard 2 metri
- Resistenza all'urto IK 08 (6J)
- Temperatura di utilizzo -15°C +60°C

Riferimenti a Norme

- Conforme alla norma CEI EN 50085-2-3
- Conforme alla Direttiva RoHS 2015/863/EU
- Conforme alla Direttiva B.T. 2014/35/EU

Marchi e Certificazioni

- Marchio IMQ (V4K,V5K,V6K) Rif. n°CA02.02387
- Marchio UL (V4K,V5K,V6K,V6H) Rif. n°ZODZ2.E197662
- Marchio CSA (V5K,V6K,V6H) Rif. n°2326493
- Marchio VDE (V6K,V6H) Rif. n°40026398 / 40026400
- Marcatura CE

Colori disponibili

- Grigio RAL7030, Grigio RAL7035, Bianco RAL9003, Blu RAL5012

Technical Features

- PVC trunkings and PC-ABS halogen free trunkings
- Standard length trunking 2 meters
- Impact resistance IK 08 (6J)
- Operating temperature -15°C +60°C

Norms Reference

- Complies with standard CEI EN 50085-2-3
- Compliant with RoHS Directive 2015/863/EU
- Compliant with the Low Voltage Directive 2014/35/EU

Marks and Certifications







- IMQ mark (V4K,V5K,V6K) Ref. n°CA02.02387
- UL mark (V4K,V5K,V6K,V6H) Ref. n°ZODZ2.E197662
- CSA mark (V5K,V6K,V6H) Ref. n°2326493
- VDE mark (V6K,V6H) Ref. n°40026398 / 40026400
- CE marking

Available colours







- Grey RAL7030, Grey RAL7035, White RAL9003, Blue RAL5012

Canale da cablaggio in PVC PVC wiring ducts

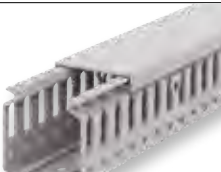
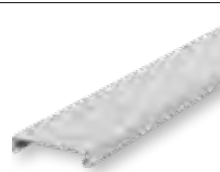

					
Dimensioni Dimensions B x H	 Grigio RAL7030 Passo 10 mm Tranciatura 4,5 mm Lamella 5,5 mm Grey RAL7030 Step 10 mm Slot 4,5 mm Segment 5,5 mm	 Grigio RAL7030 Passo 12,5 mm Tranciatura 6 mm Lamella 6,5 mm Grey RAL7030 Step 12,5 mm Slot 6 mm Segment 6,5 mm	 Bianco RAL9003 Passo 12,5 mm Tranciatura 6 mm Lamella 6,5 mm White RAL9003 Step 12,5 mm Slot 6 mm Segment 6,5 mm	 Blu RAL5012 Passo 12,5 mm Tranciatura 6 mm Lamella 6,5 mm Blue RAL5012 Step 12,5 mm Slot 6 mm Segment 6,5 mm	 Canale chiuso Grigio RAL7030 Closed trunking Grey RAL7030
25x25 mm		V6K2525	V6K2525W	V6B2525	
40x25 mm		V6K2540	V6K2540W	V6B2540	
80x25 mm		V6K2580			
25x40 mm	V5K4025	V6K4025	V6K4025W	V6B4025	
30x40 mm		V6K4030			
40x40 mm	V5K4040	V6K4040	V6K4040W	V6B4040	V0K4040
60x40 mm	V5K4060	V6K4060	V6K4060W	V6B4060	V0K4060
80x40 mm	V5K4080	V6K4080	V6K4080W		
25x60 mm	V5K6025	V6K6025	V6K6025W	V6B6025	
30x60 mm		V6K6030			
40x60 mm	V5K6040	V6K6040	V6K6040W	V6B6040	V0K6040
60x60 mm	V5K6060	V6K6060	V6K6060W	V6B6060	V0K6060
80x60 mm	V5K6080	V6K6080	V6K6080W	V6B6080	V0K6080
100x60 mm	V5K60100	V6K60100	V6K60100W	V6B60100	V0K60100
120x60 mm		V6K60120	V6K60120W		
25x80 mm	V5K8025	V6K8025	V6K8025W	V6B8025	
30x80 mm		V6K8030			
40x80 mm	V5K8040	V6K8040	V6K8040W	V6B8040	V0K8040
60x80 mm	V5K8060	V6K8060	V6K8060W	V6B8060	V0K8060
80x80 mm	V5K8080	V6K8080	V6K8080W	V6B8080	V0K8080
100x80 mm	V5K80100	V6K80100	V6K80100W	V6B80100	V0K80100
120x80 mm	V5K80120	V6K80120	V6K80120W	V6B80120	V0K80120
25x100 mm					
30x100 mm		V6K10030	V6K10030W		
40x100 mm	V5K10040	V6K10040	V6K10040W		
60x100 mm	V5K10060	V6K10060	V6K10060W	V6B10060	
80x100 mm	V5K10080	V6K10080	V6K10080W	V6B10080	
100x100 mm	V5K100100	V6K100100	V6K100100W	V6B100100	

Per informazioni tecniche vedere pagine 8-11
For technical features see pages 8-11

				
				
Coperchio di ricambio per V5K e V6K Grigio RAL7030 Replacement cover for V5K and V6K Grey RAL7030	Coperchio di ricambio per V5K e V6K Bianco RAL9003 Replacement cover for V5K and V6K White RAL9003	Coperchio di ricambio per V5K e V6K Blu RAL5012 Replacement cover for V5K and V6K Blue RAL5012	Grigio RAL7030 Passo 12,5 mm Tranciatura 6 mm Lamella 6,5 mm Grey RAL7030 Step 12,5 mm Slot 6 mm Segment 6,5 mm	Coperchio di ricambio per V4K Grigio RAL7030 Replacement cover for V4K Grey RAL7030
V25K	V25KW	V25KB	V4K2525	VC25
V40	V40W	V40B	V4K2540	VC40
V80				
V25	V25W	V25B	V4K4025	VC25
V30				
V40	V40W	V40B	V4K4040	VC40
V60	V60W	V60B	V4K4060	VC60
V80	V80W	V80B	V4K4080	VC80
V25	V25W	V25B	V4K6025	VC25
V30				
V40	V40W	V40B	V4K6040	VC40
V60	V60W	V60B	V4K6060	VC60
V80	V80W	V80B	V4K6080	VC80
V100	V100W	V100B	V4K60100	VC100
V120	V120W	V120B	V4K60120	VC120
V25	V25W	V25B	V4K8025	VC25
V30				
V40	V40W	V40B	V4K8040	VC40
V60	V60W	V60B	V4K8060	VC60
V80	V80W	V80B	V4K8080	VC80
V100	V100W	V100B	V4K80100	VC100
V120	V120W	V120B	V4K80120	VC120
			V4K10025	VC25
V30				
V40	V40W	V40B	V4K10040	VC40
V60	V60W	V60B	V4K10060	VC60
V80	V80W	V80B	V4K10080	VC80
V100	V100W	V100B	V4K100100	VC100

Canale da cablaggio **senza ALOGENI**
Wiring duct **HALOGEN free**



				
Dimensioni Dimensions B x H	 Grigio RAL7035 Passo 12,5 mm Tranciatura 6 mm Lamella 6,5 mm Grey RAL7035 Step 12,5 mm Slot 6 mm Segment 6,5 mm	 Blu RAL5012 Passo 12,5 mm Tranciatura 6 mm Lamella 6,5 mm Blu RAL5012 Step 12,5 mm Slot 6 mm Segment 6,5 mm	 Coperchio di ricambio Grigio RAL7035 Replacement cover Grey RAL7035	 Canale chiuso Grigio RAL7035 Closed trunking Grey RAL7035
25x25 mm	V6H2525		V25HK	
40x25 mm	V6H2540		V40H	
25x40 mm	V6H4025		V25H	
40x40 mm	V6H4040	V6HB4040	V40H	V0H4040
60x40 mm	V6H4060		V60H	V0H4060
80x40 mm	V6H4080		V80H	
25x60 mm	V6H6025		V25H	
40x60 mm	V6H6040		V40H	V0H6040
60x60 mm	V6H6060		V60H	V0H6060
80x60 mm	V6H6080		V80H	V0H6080
100x60 mm	V6H60100		V100H	V0H60100
120x60 mm	V6H60120		V120H	
25x80 mm	V6H8025		V25H	
40x80 mm	V6H8040	V6HB8040	V40H	
60x80 mm	V6H8060	V6HB8060	V60H	
80x80 mm	V6H8080	V6HB8080	V80H	
100x80 mm	V6H80100		V100H	
120x80 mm	V6H80120		V120H	
40x100 mm	V6H10040			
60x100 mm	V6H10060		V60H	
80x100 mm	V6H10080		V80H	
100x100 mm	V6H100100	V6HB100100	V100H	

Per informazioni tecniche vedere pagine 8-11
For technical features see pages 8-11

I3 F2 Classe di emissione fumi dei canali V6H, V6HB, V0H I3 F2 Smoke emission class of the channels V6H, V6HB, V0H

Per soddisfare i più alti standard di sicurezza la Arnocanali mette a disposizione della clientela le nuove canaline da cablaggio in PC-ABS esente da alogeni, soluzione ideale quando la sicurezza è un requisito fondamentale. In caso di incendio, infatti, questo materiale, oltre a impedire la propagazione delle fiamme, emette gas a bassissimo contenuto di sostanze tossiche e fumi non opachi, che non ostacolano la visuale. I canali V6H e V0H sono conformi alla Norma CEI 23-22, DIN 43659 (foratura canale), VDE 0472 (halogen free), UL 94 V0 (autoestinguenza).

I maggiori campi di applicazione dei prodotti Halogen free sono i seguenti:

- Ambienti in cui si radunino numerose persone (cinema, teatri, scuole, ecc), aree con particolari requisiti di sicurezza (sotterranei, metropolitane, militare, navale, ecc), impianti industriali (petrolchimici, piattaforme off-shore, centrali, ecc), mezzi di trasporto (metro, treni, navi, aerei, ecc).

In order to conform to the highest standards for the safety Arnocanali proposes to the customers the new PC-ABS halogen-free wiring ducts, which is the ideal solution in those cases where security is a fundamental requirement. Indeed, in case of fire, such material, besides avoiding the spread of flames, shoots a gas having a very low content of toxicants, as well as fumes which do not hinder the view. V6H and V0H conform to the norm CEI 23-22, DIN 43659 (trunking punching), VDE 0472 (halogen free), UL 94 V0 (self extinguishing).

The most important sectors where the halogen-free products can be used are:

- Places where many people gather frequently: (cinemas, theatres, schools), places requiring a high standard of security (undergrounds, subway stations, military, naval), industrial plants (petrochemical, off-shore platforms, power stations), means of transport (subways, trains, boats, planes).

Traversa reggicavo Cable clamp

Per canali: V5K, V6K e V6H
Materiale: policarbonato *senza ALOGENI*
For ducts: V5K, V6K and V6H
Material: polycarbonate *HALOGEN free*

Articolo Item	VTK6
	

Spessore canali da cablaggio Thickness of wiring trunkings

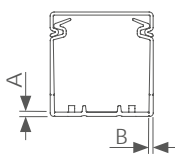
	V4K		V5K V6K V6B V0K		V6H V6HB V0H	
	A mm	B mm	A mm	B mm	A mm	B mm
Altezza canale Trunking Height						
25 mm	1,4	1,4	1,4	1,3	1,4	1,3
40 mm	1,4	1,4	1,5	1,4	1,5	1,4
60 mm	1,8	1,8	1,7	1,6	1,7	1,6
80 mm	1,8	1,8	2,1	2,0	2,1	2,0
100 mm	2,2	2,2	2,5	2,4	2,5	2,4
120 mm	2,5	2,5	-	-	-	-

Sezione utile e capacità di contenimento cavi Useful section and cable containment capacity

N. Conducenti inseribili tipo H07V-U/R/K N. of insertable cables type H07V-U/R/K										
V4K	V5K	V6K	V6B	V6H	V6HB	Dimensioni Dimension	Sezione utile Cross section	1 mm ²	1,5 mm ²	2,5 mm ²
						B x H mm	mm ²			
V4K2525		V6K2525	V6B2525	V6H2525		25x25	410	39	28	19
V4K2540		V6K2540	V6B2540	V6H2540		40x25	747	71	51	35
		V6K2580				80x25	1.647	156	113	78
V4K4025	V5K4025	V6K4025	V6B4025	V6H4025		25x40	701	66	48	33
		V6K4030				30x40	852	78	56	39
V4K4040	V5K4040	V6K4040	V6K4040	V6H4040	V6HB4040	40x40	1.227	116	84	58
V4K4060	V5K4060	V6K4060	V6K4060	V6H4060		60x40	1.925	183	132	92
V4K4080	V5K4080	V6K4080		V6H4080		80x40	2.715	258	187	129
V4K6025	V5K6025	V6K6025	V6B6025	V6H6025		25x60	1.141	108	78	54
		V6K6030				30x60	1.392	132	96	66
V4K6040	V5K6040	V6K6040	V6B6040	V6H6040		40x60	1.967	187	135	94
V4K6060	V5K6060	V6K6060	V6B6060	V6H6060		60x60	3.105	295	214	148
V4K6080	V5K6080	V6K6080	V6B6080	V6H6080		80x60	4.255	405	293	203
V4K60100	V5K60100	V6K60100	V6B60100	V6H60100		100x60	5.405	514	372	258
V4K60120	V5K60120	V6K60120		V6H60120		120x60	6.320	601	435	302
V4K8025	V5K8025	V6K8025	V6B8025	V6H8025		25x80	1.581	150	109	75
		V6K8030				30x80	1.932	184	133	92
V4K8040	V5K8040	V6K8040	V6B8040	V6H8040	V6HB8040	40x80	2.707	257	186	129
V4K8060	V5K8060	V6K8060	V6B8060	V6H8060	V6HB8060	60x80	4.245	404	292	203
V4K8080	V5K8080	V6K8080	V6B8080	V6H8080	V6HB8080	80x80	5.795	551	399	277
V4K80100	V5K80100	V6K80100	V6B80100	V6H80100		100x80	7.345	699	506	351
V4K80120	V5K80120	V6K80120	V6B80120	V6H80120		120x80	8.895	847	613	425
V4K10025						25x100	1.977	188	136	95
		V6K10030				30x100	2.471	235	170	118
V4K10040	V5K10040	V6K10040				40x100	3.446	328	237	164
V4K10060	V5K10060	V6K10060	V6B10060	V6H10060		60x100	5.385	512	371	257
V4K10080	V5K10080	V6K10080	V6B10080	V6H10080		80x100	7.335	698	505	350
V4K100100	V5K100100	V6K100100	V6B100100	V6H100100		100x100	9.285	884	640	444

6 motivi per scegliere i canali da cablaggio V5K/V6K/V6H

- 1 - Chiusura del coperchio facilitata
- 2 - Asola per inserimento fascette sul fondo del canale
- 3 - Costole d'irrigidimento sul fondo del canale
- 4 - Zigrinatura per una maggiore aderenza con adesivi
- 5 - Prerottura interna ed esterna della lamella e del fondo
- 6 - Coperchio con coestruso morbido antiscivolo sui canali V5K e V6K

6 grounds to choose the wiring ducts V5K/V6K/V6H

- 1 - Easiness closing cover
- 2 - Loops on the bottom to insert cable ties
- 3 - Stiffen up guide on the bottom of trunking
- 4 - Milling for more grip with adhesive
- 5 - Internal and external precutted segment and bottom
- 6 - Cover with non-slip soft coextruded on the V5K and V6K ducts



Dimensioni tranciatura dei fianchi del canale Wall punching dimensions of the ducts

V4K				
Altezza 25 mm Height 25 mm	Altezza 40 mm Height 40 mm	Altezza 60 mm Height 60 mm	Altezza 80 mm Height 80 mm	Altezza 100 mm Height 100 mm
V5K				
Altezza 25 mm Height 25 mm	Altezza 40 mm Height 40 mm	Altezza 60 mm Height 60 mm	Altezza 80 mm Height 80 mm	Altezza 100 mm Height 100 mm
V6K - V6B - V6H				
Altezza 25 mm Height 25 mm	Altezza 40 mm Height 40 mm	Altezza 60 mm Height 60 mm	Altezza 80 mm Height 80 mm	Altezza 100 mm Height 100 mm

Schema di foratura delle basi Bases punching scheme

V4K			
Larghezza 25, 40 mm Width 25, 40 mm	Larghezza 60 mm Width 60 mm	Larghezze 80, 100 mm Width 80, 100 mm	Larghezze 120 mm Width 120 mm
V5K, V6K, V6B, V0K			
Larghezza 25, 40 mm Width 25, 40 mm	Larghezza 60 mm Width 60 mm	Larghezze 80, 100 mm Width 80, 100 mm	Larghezze 120 mm Width 120 mm
V6H, V6HB, V0H			
Larghezza 25, 40 mm Width 25, 40 mm	Larghezza 60 mm Width 60 mm	Larghezze 80, 100 mm Width 80, 100 mm	Larghezze 120 mm Width 120 mm



Canalina flessibile con adesivo Flexible wire duct with adhesive

Materiale: Poliammide Senza Alogeni
Colore: Grigio RAL7030
Temperatura d'esercizio: -25°C +90°C
Infiammabilità: UL94 V0
Certificazioni: UL, CSA
Conformità: CE, RoHS 2015/863/EU

Material: Polyamide Halogen Free
Colour: Grey RAL7030
Working temperature: -25°C +90°C
Flammability: UL94 V0
Certifications: UL, CSA
Compliance: CE, RoHS 2015/863/EU

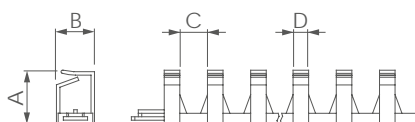

art. V10R

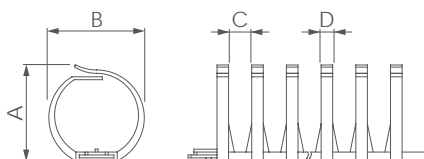

art. V20R
V30R
V40R

Articolo Item	Lunghezza Length	Sezione Section	Dimensioni Dimensions			
			A mm	B mm	C mm	D mm
V10R	250 mm	82 mm ²	10	10	8	4,5
V20R	500 mm	300 mm ²	20	20	8	4,5
V30R	500 mm	620 mm ²	30	30	8	4,5
V40R	500 mm	1.050 mm ²	40	40	8	4,5

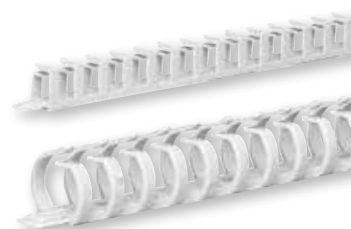

Spirale per cablaggio cavi Wiring harness spiral

Materiale: Polietilene
Colore: Trasparente
Temperatura d'esercizio: -40°C +60°C
Infiammabilità: UL94 HB
Conformità: CE, RoHS 2015/863/EU

Material: Polyethylene
Colour: Transparent
Working temperature: -40°C +60°C
Flammability: UL94 HB
Compliance: CE, RoHS 2015/863/EU

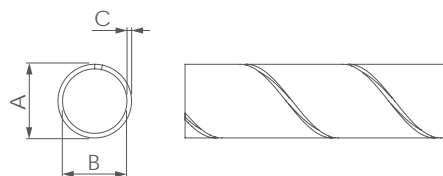

Articolo Item	Lunghezza rotolo Roll length	Dimensioni Dimensions		
		A mm	B mm	C mm
VS6	10 m	6	4	1
VS8	10 m	8	6	1
VS10	10 m	10	7,5	1,25
VS12	10 m	12	9	1,5
VS16	10 m	16	13	1,5
VS20	10 m	20	16	2
VS25	10 m	25	20	2,5



Guaina trecciata estensibile Expansible braided sleeve

Materiale: Poliestere Senza Alogeni Colore: Nero, Grigio Diámetro filato: 0,22 mm Temperatura d'esercizio: -40°C +150°C Inflammabilità: UL94 V2 Conformità: CE, RoHS 2015/863/EU Normativa: DIN 5510 parte 2		Material: Polyester Halogen Free Colour: Black, Grey Filament diameter: 0,22 mm Working temperature: -40°C +150°C Flammability: UL94 V2 Compliance: CE, RoHS 2015/863/EU Standard: DIN 5510 parte 2		
Articolo Item		Dimensioni Dimensions	Estensione Extension Ø	Lunghezza rotolo Roll length
Nero Black	Grigio Grey			
GNB05PE	GGB05PE	Ø5 mm	Da 3 a 10 mm From 3 to 10 mm	100 m
GNB10PE	GGB10PE	Ø10 mm	Da 8 a 18 mm From 8 to 18 mm	100 m
GNB15PE	GGB15PE	Ø15 mm	Da 10 a 22 mm From 10 to 22 mm	50 m
GNB20PE	GGB20PE	Ø20 mm	Da 15 a 30 mm From 15 to 30 mm	50 m
GNB25PE	GGB25PE	Ø25 mm	Da 23 a 38 mm From 23 to 38 mm	50 m
GNB30PE	GGB30PE	Ø30 mm	Da 28 a 49 mm From 28 to 49 mm	50 m
GNB40PE	GGB40PE	Ø40 mm	Da 34 a 60 mm From 34 to 60 mm	50 m
GNB50PE	GGB50PE	Ø50 mm	Da 45 a 80 mm From 45 to 80 mm	50 m



Guaina trecciata estensibile con Velcro Expansible braided sleeve with Velcro

Materiale guaina: Poliestere Materiale Velcro: Poliammide Colore: Nero Temperatura d'esercizio: -50°C +150°C Inflammabilità: VW-1 Conformità: CE, RoHS 2015/863/EU		Wrap material: Polyester Velcro material: Polyamide Colour: Black Working temperature: -50°C +150°C Flammability: VW-1 Compliance: CE, RoHS 2015/863/EU	
Articolo Item		Dimensioni Dimensions	Estensione Extension Ø
MGE30	Bobina da 25 m Reel 25 m		
MGE30	Bobina da 25 m Reel 25 m	Ø30 mm	Da 75 a 100 mm From 75 to 100 mm
MGE50	Bobina da 25 m Reel 25 m	Ø50 mm	Da 90 a 120 mm From 90 to 120 mm
MGE30B	Blister 1,5 m Blister 1,5 m		
MGE30B	Blister 1,5 m Blister 1,5 m	Ø30 mm	Da 75 a 100 mm From 75 to 100 mm
MGE50B	Blister 1,5 m Blister 1,5 m		
MGE50B	Blister 1,5 m Blister 1,5 m	Ø50 mm	Da 90 a 120 mm From 90 to 120 mm



Guide metalliche in acciaio elettrozincato Metallic rails in electrogalvanized steel



Materiale: Acciaio
Trattamento: Zincatura elettrolitica e passivazione
Dimensione asole: 18x5 mm con passo 25 mm
Lunghezza guide: 2.000 mm
Conformità: CE, RoHS 2015/863/EU
Normativa: CEI EN 60715

Material: Steel
Treatment: Electrogalvanized and passivation
Slot size: 18x5 mm with 25 mm pitch
Rails length: 2.000 mm
Compliance: CE, RoHS 2015/863/EU
Standard: CEI EN 60715

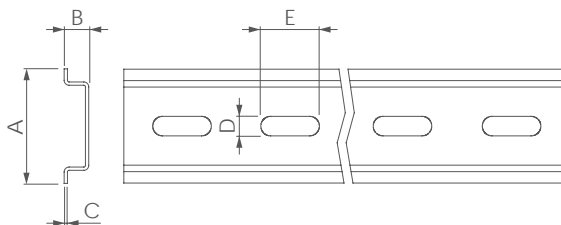

Sezione Section	Articolo Item	Modello Model	Fondo Bottom	Dimensioni Dimensions				
				A mm	B mm	C mm	D mm	E mm
	534-2	G1	Chiuso Closed	32	15	1,5	5	18
	534LO-2	G1F	Forato Slotted	32	15	1,5	5	18
	536-2	OMEGA 3	Chiuso Closed	35	7,5	1	5	18
	536LO-2	OMEGA 3F	Forato Slotted	35	7,5	1	5	18
	537-2	OMEGA 3A	Chiuso Closed	35	15	1,5	5	18
	537LO-2	OMEGA 3AF	Forato Slotted	35	15	1,5	5	18



Staffa di supporto inclinata per guide metalliche Inclined support bracket for metallic rails



Materiale: Acciaio
Trattamento: Zincatura elettrolitica e passivazione
Conformità: CE, RoHS 2015/863/EU
Normativa: CEI EN 60715

Material: Steel
Treatment: Electrogalvanized and passivation
Compliance: CE, RoHS 2015/863/EU
Standard: CEI EN 60715

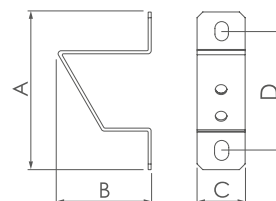

Articolo Item	Fori fissaggio Fixing holes	Filettatura foro Hole thread	A mm	B mm	C mm	D mm
752	Ø7 mm	M6	7,4	5	1,9	3,7



Morsetto di terra per guide metalliche Earthing clamp for metal rails



<p>Materiale morsetto: Ottone Materiale viti: Acciaio zincato Conformità: CE, RoHS 2015/863/EU Normativa: CEI EN 60715</p> <p>Clamp material: Brass Screw material: Galvanized steel Compliance: CE, RoHS 2015/863/EU Standard: CEI EN 60715</p>					
Articolo Item	Foro cavi Cable hole	Sezione cavo Cable section			
BTM	1 x Ø5,2 mm	Max 16 mm ²			

Applicarivetti Rivets applicator



<p>Adatto per: Fissaggio canali da cablaggio Materiale: Poliammide e Alluminio Conformità: CE, RoHS 2015/863/EU</p> <p>Suitable for: Fixing of wiring ducts Material: Polyamide and Aluminium Compliance: CE, RoHS 2015/863/EU</p>							
Articolo Item	Per rivetti For rivets						
VR140	Ø4 mm						
VR160	Ø6 mm						

Rivetti in plastica Plastic rivets



<p>Adatti per: Fissaggio di canali da cablaggio Materiale: Nylon Conformità: CE, RoHS 2015/863/EU</p> <p>Suitable for: Fixing of wiring ducts Material: Nylon Compliance: CE, RoHS 2015/863/EU</p>							
Articolo Item	Dimensione Dimension						
VRV40	Ø 4 mm						
VRV60	Ø 6 mm						

Viti autoperforanti Self drilling screws



<p>Adatte per: Fissaggio di canali da cablaggio Materiale: Acciaio Inox e Nylon Conformità: CE, RoHS 2015/863/EU</p> <p>Suitable for: Fixing of wiring ducts Material: Stainless steel / Nylon Compliance: CE, RoHS 2015/863/EU</p>							
Articolo Item	Dimensione Dimension						
V7900	Ø4,2x13 mm						

Cesoia per taglio pareti canali Shearing tool for wall ducts



<p>Adatta per: taglio delle pareti dei canali Materiale: Acciaio Conformità: CE, RoHS 2015/863/EU Accessori: con custodia e cacciavite a taglio</p> <p>Suitable for: cutting the walls of the ducts Material: Steel Compliance: CE, RoHS 2015/863/EU Accessories: with case and screwdriver</p>	Articolo Item	
	V910	

Cesoia taglio canali Cutting tool



<p>Adatta per: taglio di canali max larghezza 120 mm Materiale: Acciaio Conformità: CE, RoHS 2015/863/EU</p> <p>Suitable for: cutting of ducts max width 120 mm Material: Steel Compliance: CE, RoHS 2015/863/EU</p>	
Articolo Item	
KTC120	
KTC120L	lama di ricambio replacement blade

Forbici taglio canali Cutting shears



<p>Adatta per: Taglio di canali max larghezza 60 mm Materiale: Acciaio Conformità: CE, RoHS 2015/863/EU</p> <p>Suitable for: Cutting of ducts max width 60 mm Material: Steel Compliance: CE, RoHS 2015/863/EU</p>	
Articolo Item	
KTC	
KTCL	lama di ricambio replacement blade

Paralama di ricambio Replacement protection



<p>Per cesoia: VTC125B Materiale: Acciaio Conformità: CE, RoHS 2015/863/EU</p> <p>For cutting: VTC125B Material: Steel Compliance: CE, RoHS 2015/863/EU</p>	
Articolo Item	
VTC125PL	

Lama di ricambio Replacement blade



<p>Per cesoia: VTC125B Materiale: Acciaio Inox Conformità: CE, RoHS 2015/863/EU</p> <p>For cutting: VTC125B Material: Stainless Steel Compliance: CE, RoHS 2015/863/EU</p>	
Articolo Item	
VTC125L	

Cesoia da banco per canali da cablaggio Bench mounting wiring duct cutting tool



Articolo: VTC125B
Materiale: Acciaio e Alluminio
Dimensione: 1340x290x810 mm
Peso cesoia e vassoio: 19 Kg
Larghezza max taglio: 125 mm
Lunghezza max taglio: 1.000 mm
Scala graduata: Metrica e pollici
Conformità: CE, RoHS 2015/863/EU

Item: VTC125B
Material: Steel and Aluminium
Dimensions: 1340x290x810 mm
Shear and tray weight: 19 Kg
Max cutting width: 125 mm
Max cutting length: 1.000 mm
Graduated scale: Metric and Inches
Compliance: CE, RoHS 2015/863/EU



- Non produce scarto e polvere
- La lama può essere sostituita o affilata
- It does not produce waste and dust
- The blade can be replaced or re-sharpened

Cesoia da banco per guide DIN Bench mounting DIN rail cutting tool



Articolo: VTG-2
Materiale: Acciaio e Alluminio
Dimensione cesoia: 1350x150x710 mm
Lunghezza asta graduata: 1.000 mm
Peso cesoia e asta graduata: 10 Kg
Lunghezza max taglio: 1.000 mm
Scala graduata: Metrica e pollici
Conformità: CE, RoHS 2015/863/EU

Item: VTG-2
Material: Steel and Aluminium
Cutting size: 1350x150x710 mm
Graduated rod length: 1.000 mm
Cutting weight and graduated rod: 10 Kg
Max cutting length: 1.000 mm
Graduated scale: Metric and Inches
Compliance: CE, RoHS 2015/863/EU

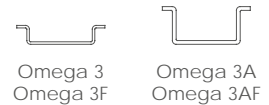

Articolo: VTG-5
Materiale: Acciaio e Alluminio
Dimensione cesoia: 1350x150x710 mm
Lunghezza asta graduata: 1.000 mm
Peso cesoia e asta graduata: 11 Kg
Lunghezza max taglio: 1.000 mm
Scala graduata: Metrica e pollici
Conformità: CE, RoHS 2015/863/EU

Item: VTG-5
Material: Steel and Aluminium
Cutting size: 1350x150x710 mm
Graduated rod length: 1.000 mm
Cutting weight and graduated rod: 11 Kg
Max cutting length: 1.000 mm
Graduated scale: Metric and Inches
Compliance: CE, RoHS 2015/863/EU

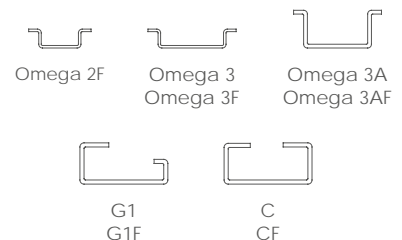
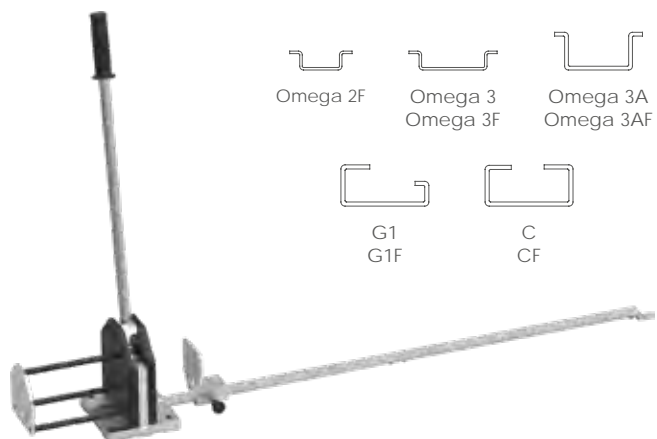

Morsettiere di ripartizione per quadri elettrici

Distribution terminal posts for panels



<p>Certificazioni: IMQ, * UL Conformità: CE, RoHS 2015/863/EU Normative: EN 60998-1:2004 Materiale fiancate: Poliammide Materiale coperchio: Policarbonato Materiale Barre: Ottone Materiale viti: acciaio zincato Temperatura d'esercizio: -5°C +85°C Resistenza al calore: 130°C Tensione di isolamento Ui: 1000 V</p>	<p>Certifications: IMQ, * UL Compliance: CE, RoHS 2015/863/EU Standards: EN 60998-1: 2004 Sides material: Polyamide Cover material: Polycarbonate Bars material: Brass Screws material: zinc plated steel Working temperature: -5°C +85°C Heat resistance: 130°C Rated insulation voltage Ui: 1000 V</p>	

Articolo Item	Corrente nominale Rated current	Numero poli Number poles	N. fori per polo N. holes for pole	Dimensione fori per barra Dimension holes for bar	Sezione max per barra Max section for bar	I _{pk}	I _{cw}	U _{imp}	Potenza dissipata per barra Dissipated power per bar		Dimensioni Dimensions		
									kA	kA	kV	25°C	85°C
BR82.63	63 A	2	8	2xØ6 mm 6xØ5,3 mm	2x16 mm ² 6x10 mm ²	20	3	8	0,65W	0,76W	45	68	47
BR132.63	63 A	2	13	2xØ6 mm 11xØ5,3 mm	2x16 mm ² 11x10 mm ²	20	3	8	1,04W	1,23W	45	105	47
BR72.100 *	125 A	2	7	1xØ9 mm 1xØ8 mm 5xØ6 mm	1x35 mm ² 1x25 mm ² 5x10 mm ²	22	6	8	1,36W	1,46W	45	68	47
BR112.125	125 A	2	11	1xØ9 mm 2xØ8 mm 2xØ7 mm 6xØ6 mm	1x35 mm ² 2x25 mm ² 2x16 mm ² 6x10 mm ²	22	6	8	4,10W	4,85W	45	105	47
BR152.125 *	125 A	2	15	1xØ9 mm 2xØ8 mm 2xØ7 mm 10xØ6 mm	1x35 mm ² 2x25 mm ² 2x16 mm ² 10x10 mm ²	22	6	8	5,27W	6,30W	45	134	47

<p>Certificazioni: IMQ, * UL Conformità: CE, RoHS 2015/863/EU Normative: EN 60998-1:2004 Materiale fiancate: Poliammide Materiale coperchio: Policarbonato Materiale Barre: Ottone Materiale viti: acciaio zincato Temperatura d'esercizio: -5°C +85°C Resistenza al calore: 130°C Tensione di isolamento Ui: 1000 V</p>	<p>Certifications: IMQ, * UL Compliance: CE, RoHS 2015/863/EU Standards: EN 60998-1: 2004 Sides material: Polyamide Cover material: Polycarbonate Bars material: Brass Screws material: zinc plated steel Working temperature: -5°C +85°C Heat resistance: 130°C Rated insulation voltage Ui: 1000 V</p>	
---	---	--

BR84.63	63 A	4	8	2xØ6 mm 6xØ5,3 mm	2x16 mm ² 6x10 mm ²	20	3	8	0,65W	0,76W	45	72	98
BR134.63	63 A	4	13	2xØ6 mm 11xØ5,3 mm	2x16 mm ² 11x10 mm ²	20	3	8	1,04W	1,23W	45	109	98
BR74.100 *	125 A	4	7	1xØ9 mm 1xØ8 mm 5xØ6 mm	1x35 mm ² 1x25 mm ² 5x10 mm ²	22	6	8	1,36W	1,46W	45	72	98
BR114.125 *	125 A	4	11	1xØ9 mm 2xØ8 mm 2xØ7 mm 6xØ6 mm	1x35 mm ² 2x25 mm ² 2x16 mm ² 6x10 mm ²	22	6	8	4,10W	4,85W	45	109	98
BR154.125 *	125 A	4	15	1xØ9 mm 2xØ8 mm 2xØ7 mm 10xØ6 mm	1x35 mm ² 2x25 mm ² 2x16 mm ² 10x10 mm ²	22	6	8	5,27W	6,30W	45	138	98

Morsettiere di ripartizione per quadri elettrici

Distribution terminal posts for panels



<p>Certificazioni: IMQ Conformità: CE, RoHS 2015/863/EU Normative: EN 60998-1:2004 Materiale fiancate: Poliammide Materiale coperchio: Policarbonato Materiale Barre: Ottone Materiale viti: acciaio zincato Temperatura d'esercizio: -5°C +85°C Resistenza al calore: 130°C Tensione di isolamento Ui: 1000 V</p>	<p>Certifications: IMQ Compliance: CE, RoHS 2015/863/EU Standards: EN 60998-1: 2004 Sides material: Polyamide Cover material: Polycarbonate Bars material: Brass Screws material: zinc plated steel Working temperature: -5°C +85°C Heat resistance: 130°C Rated insulation voltage Ui: 1000 V</p>	

Articolo Item	Corrente nominale Rated current	Numero poli Number poles	N. fori per polo N. holes for pole	Dimensione fori per barra Dimension holes for bar	Max sezione per barra Max section for bar	I _{pk}	I _{cw}	U _{imp}	Potenza dissipata per barra Dissipated power per bar		Dimensioni Dimensions		
									25°C	85°C	A mm	B mm	C mm
BD10074	125 A	4	7	1xØ9 mm 1xØ8 mm 5xØ6 mm	1x35 mm ² 1x25 mm ² 5x10 mm ²	22	6	8	1,36W	1,46W	45	72	98
BD125114	125 A	4	11	1xØ9 mm 2xØ8 mm 2xØ7 mm 6xØ6 mm	1x35 mm ² 2x25 mm ² 2x16 mm ² 6x10 mm ²	22	6	8	4,10W	4,85W	45	109	98
BD125154	125 A	4	15	1xØ9 mm 2xØ8 mm 2xØ7 mm 10xØ6 mm	1x35 mm ² 2x25 mm ² 2x16 mm ² 10x10 mm ²	22	6	8	5,27W	6,30W	45	138	98

<p>Certificazioni: IMQ, UL Conformità: CE, RoHS 2015/863/EU Normative: EN 60998-1:2004 Materiale fiancate: Poliammide Materiale coperchio: Policarbonato Materiale Barre: Ottone Materiale viti: acciaio zincato Temperatura d'esercizio: -5°C +85°C Resistenza al calore: 130°C</p>	<p>Certifications: IMQ, UL Compliance: CE, RoHS 2015/863/EU Standards: EN 60998-1: 2004 Sides material: Polyamide Cover material: Polycarbonate Bars material: Brass Screws material: zinc plated steel Working temperature: -5°C +85°C Heat resistance: 130°C</p>												
BD16084	160 A	4	8	1xØ12 mm 1xØ9 mm 1xØ8 mm 5xØ7 mm	1x50 mm ² 1x35 mm ² 1x25 mm ² 5x16 mm ²	24	10	8	2,82W	3,17W	70	133	136
BD160134	160 A	4	13	1xØ12 mm 2xØ9 mm 2xØ8 mm 8xØ7 mm	1x50 mm ² 2x35 mm ² 2x25 mm ² 8x16 mm ²	24	10	8	4,39W	4,93W	70	186	136
BD160135	160 A	5	13	1xØ12 mm 2xØ9 mm 2xØ8 mm 8xØ7 mm	1x50 mm ² 2x35 mm ² 2x25 mm ² 8x16 mm ²	24	10	8	4,39W	4,93W	70	186	136

Barrette di espansione 5° polo

5° Pole expansion bars

507N	5011N	5015N	BD1608	BD16013
7 fori/holes 125A	11 fori/holes 125A	15 fori/holes 125A	8 fori/holes 160A	13 fori/holes 160A

BOXDIN 2 morsettiere di ripartizione per quadri elettrici BOXDIN 2 distribution terminal posts for panels



<p>Certificazioni: IMQ Conformità: CE, RoHS 2015/863/EU Normative: EN 60998-1:2004 Materiale basi: Poliammide Materiale coperchio: Policarbonato Materiale Barre: Ottone Materiale viti: acciaio zincato Temperatura d'esercizio: -5°C +85°C Resistenza al calore: 130°C</p>	<p>Certifications: IMQ Compliance: CE, RoHS 2015/863/EU Standards: EN 60998-1: 2004 Bases material: Polyamide Cover material: Polycarbonate Bars material: Brass Screws material: zinc plated steel Working temperature: -5°C +85°C Heat resistance: 130°C</p>	
---	---	--

Articolo Item	Corrente nominale Rated current	Numero poli Number poles	N. fori per polo N. holes for pole	Dimensione fori per barra Dimension holes for bar	Max sezione per barra Max section for bar	I_{pk}	I_{cw}	U_{imp}	Potenza dissipata per barra Dissipated power per bar		Dimensioni Dimensions		
						kA	kA	kV	25°C	85°C	A mm	B mm	C mm
BD5072	63 A	2	7	2xØ6 mm 5xØ5,3 mm	2x16 mm ² 5x10 mm ²	12	1,9	8	0,53W	0,63W	45	59	68
BD50112	63 A	2	11	2xØ6 mm 9xØ5,3 mm	2x16 mm ² 9x10 mm ²	12	1,9	8	0,83W	0,98W	45	88	68
BD5074	63 A	4	7	2xØ6 mm 5xØ5,3 mm	2x16 mm ² 5x10 mm ²	12	1,9	8	0,53W	0,63W	45	59	110
BD50114	63 A	4	11	2xØ6 mm 9xØ5,3 mm	2x16 mm ² 9x10 mm ²	12	1,9	8	0,83W	0,98W	45	88	110

<p>Certificazioni: IMQ Conformità: CE, RoHS 2015/863/EU Normative: EN 60998-1:2004 Materiale fiancate: Poliammide Materiale coperchio: Policarbonato Materiale Barre: Ottone Materiale viti: acciaio zincato Temperatura d'esercizio: -5°C +85°C Resistenza al calore: 130°C Tensione di isolamento U_i: 1000 V</p>	<p>Certifications: IMQ Compliance: CE, RoHS 2015/863/EU Standards: EN 60998-1: 2004 Sides material: Polyamide Cover material: Polycarbonate Bars material: Brass Screws material: zinc plated steel Working temperature: -5°C +85°C Heat resistance: 130°C Rated insulation voltage U_i: 1000 V</p>	

BD12574D	125 A	4	7	1xØ9 mm 1xØ8 mm 5xØ6 mm	1x35 mm ² 1x25 mm ² 5x10 mm ²	22	6	8	1,36W	1,46W	50	95	102
BD125114D	125 A	4	11	1xØ9 mm 2xØ8 mm 2xØ7 mm 6xØ6 mm	1x35 mm ² 2x25 mm ² 2x16 mm ² 6x10 mm ²	22	6	8	4,10W	4,85W	50	132	102
BD125154D	125 A	4	15	1xØ9 mm 2xØ8 mm 2xØ7 mm 10xØ6 mm	1x35 mm ² 2x25 mm ² 2x16 mm ² 10x10 mm ²	22	6	8	5,27W	6,30W	50	162	102
BD16084D	160 A	4	8	1xØ12 mm 1xØ9 mm 1xØ8 mm 5xØ7 mm	1x50 mm ² 1x35 mm ² 1x25 mm ² 5x16 mm ²	24	10	8	2,82W	3,17W	55	131	102
BD160134D	160 A	4	13	1xØ12 mm 2xØ9 mm 2xØ8 mm 8xØ7 mm	1x50 mm ² 2x35 mm ² 2x25 mm ² 8x16 mm ²	24	10	8	4,39W	4,93W	55	185	102
BD160184D	160 A	4	18	1xØ12 mm 2xØ9 mm 2xØ8 mm 9xØ7 mm 4xØ6 mm	1x50 mm ² 2x35 mm ² 2x25 mm ² 9x16 mm ² 4x10 mm ²	24	10	8	5,70W	6,40W	55	230	102

BOXDIN 3 morsettiere di ripartizione per quadri elettrici BOXDIN 3 distribution terminal posts for panels



<p>Certificazioni: IMQ Conformità: CE, RoHS 2015/863/EU Normative: EN 60998-1:2004 Materiale fiancate: Poliammide Materiale coperchio: Policarbonato Materiale Barre: Ottone Materiale viti: acciaio zincato Temperatura d'esercizio: -5°C +85°C Resistenza al calore: 130°C Tensione di isolamento U_i: 1000 V</p>	<p>Certifications: IMQ Compliance: CE, RoHS 2015/863/EU Standards: EN 60998-1: 2004 Sides material: Polyamide Cover material: Polycarbonate Bars material: Brass Screws material: zinc plated steel Working temperature: -5°C +85°C Heat resistance: 130°C Rated insulation voltage U_i: 1000 V</p>	

Articolo Item	Corrente nominale Rated current	Numero poli Number poles	N. fori per polo N. holes for pole	Dimensione fori per barra Dimension holes for bar	Max sezione per barra Max section for bar	I _{pk}	I _{cw}	U _{imp}	Potenza dissipata per barra Dissipated power for bar		Dimensioni Dimensions		
									25°C	85°C	A mm	B mm	C mm
BD125104	125 A	4	10 fori	1xØ9 mm 2xØ8 mm 2xØ7 mm 5xØ6 mm	1x35 mm ² 2x25 mm ² 2x16 mm ² 5x10 mm ²	22	6	8	4,0W	4,7W	45	149	103
BD125164	125 A	4	16 fori	1xØ9 mm 2xØ8 mm 2xØ7 mm 11xØ6 mm	1x35 mm ² 2x25 mm ² 2x16 mm ² 11x10 mm ²	22	6	8	5,5W	6,8W	45	201	103
BD160104	160 A	4	10 fori	1xØ12 mm 1xØ9 mm 1xØ8 mm 7xØ7 mm	1x50 mm ² 1x35 mm ² 1x25 mm ² 7x16 mm ²	24	10	8	3,0W	3,5W	45	165	103
BD160164	160 A	4	16 fori	1xØ12 mm 2xØ9 mm 2xØ8 mm 11xØ7 mm	1x50 mm ² 2x35 mm ² 2x25 mm ² 11x16 mm ²	24	10	8	5,0W	5,60W	70	228	103

Barrette di espansione 5° polo 5° Pole expansion bars

Articolo Item	BD12510	BD12516	BD16010	BD16016
Per morsettiere For terminals	10 fori/holes 125A	16 fori/holes 125A	10 fori/holes 160A	16 fori/holes 160A



Le morsettiere BOXDIN 2 si cablano da 2 lati, 2 barre a destra e 2 barre a sinistra









The terminal posts BOXDIN2 have a wiring system from 2 sides, 2 bars right and 2 bars left

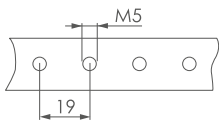

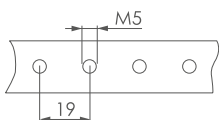
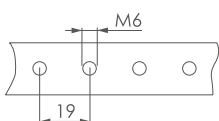
Nelle morsettiere BOXDIN 3 il cablaggio del conduttore primario è separato dai cavi di distribuzione

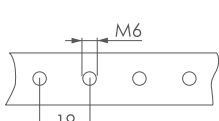
In the terminal posts BOXDIN 3 the main wire is cabled separately from distribution wires

Barre in rame filettate
Threaded copper bars

		Articolo Item	Dimensioni Dimension	Lunghezza Length	Corrente Nominale Rated current	Passo Pitch	Filettatura Thread
		BCF122-1	12x2 mm	1,00 m	65A	19 mm	M5
		BCF124-1	12x4 mm	1,00 m	125A	19 mm	M5
		BCF124	12x4 mm	1,75 m	125A	19 mm	M5
		BCF124-2	12x4 mm	2,00 m	125A	19 mm	M5
		BCF154-1	15x4 mm	1,00 m	160A	19 mm	M5
		BCF154	15x4 mm	1,75 m	160A	19 mm	M5
		BCF154-2	15x4 mm	2,00 m	160A	19 mm	M5
		BCF205-1	20x5 mm	1,00 m	250A	19 mm	M6
		BCF205	20x5 mm	1,75 m	250A	19 mm	M6
		BCF205-2	20x5 mm	2,00 m	250A	19 mm	M6
		BCF255-1	20x5 mm	1,00 m	250A	25 mm	M6
		BCF255-2	20x5 mm	2,00 m	250A	25 mm	M6
		BCF256-1	25x6 mm	1,00 m	400A	19 mm	M6
		BCF256	25x6 mm	1,75 m	400A	19 mm	M6
		BCF256-2	25x6 mm	2,00 m	400A	19 mm	M6
		BCF305-1	30x5 mm	1,00 m	400A	25 mm	M6
		BCF305-2	30x5 mm	2,00 m	400A	25 mm	M6
		BCF325-1	30x5 mm	1,00 m	400A	25x2 mm	M6
		BCF325-2	30x5 mm	2,00 m	400A	25x2 mm	M6
		BCF310-1	30x10 mm	1,00 m	630A	25 mm	M6
		BCF310-2	30x10 mm	2,00 m	630A	25 mm	M6

Isolatori portabarre
Insulating bar holder

Articolo Item	BP25M6	BP30M8	BP35M8	BP50M8	BP75M10	
Altezza Height	25 mm	30 mm	35 mm	50 mm	75 mm	
Filettatura Thread	M6	M8	M8	M8	M10	

SUPPORTI α SCALETTA LADDER HOLDER	Articolo Item	Per barre For bars	Corrente nominale Rated current
	BB416	12x4 mm 15x4 mm	125 A 160 A
	BB420	20x5 mm	250 A
	BB425	25x6 mm	400 A
	BB430	30x5 mm 30x10mm	400 A 630 A

SUPPORTI PIANI FLAT HOLDER	Articolo Item	Per barre For bars	Corrente nominale Rated current
	BS420	15x4 mm 20x5 mm 25x6 mm	160 A 250 A 400 A
	BS430	30x5 mm 30x10 mm	400 A 630 A

COPERCHI Lunghezza 1 m COVERS LENGTH 1 m	Articolo Item	Per supporto For holders
	BB2150	BB416
	BB2250	BB420
	BB2200	BB425
	BB2275	BB430 BS420 BS430

Viti con rondelle Screws and washers

Articolo Item	Dimensione Dimension	Materiale Material
	BBM59	M5 x 9 mm
	BBM610	M6 x 10 mm
	BBM612	M6 x 12 mm
		Acciaio zincato Zinc plated steel

COPERCHIO copriguida Lunghezza 1 m COVERS for DIN Rail LENGTH 1 m	Articolo Item	Per guida For rail
	BCDIN	Omega 3 Omega 3A

Morsettiera universale di derivazione Universal derivation terminal

Articolo Item	BCFD	
Fori Holes	7x16 mm ²	

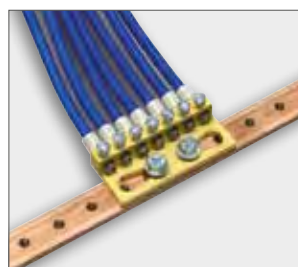

Ripartitori quadripolari versione a Scaletta

Quadripolar distribution frames Ladder version

160A passo - pitch 19

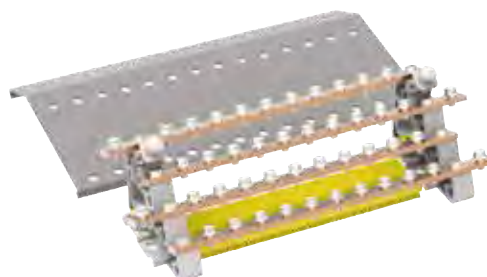
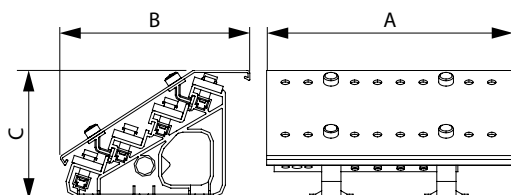

Articolo Item		BBD1606	BBD16011	BBD16017
Corrente nominale Rated current		160A	160A	160A
Sezione barra e passo fori Bar section and holes pitch		15x4 mm Passo - Pitch 19 mm	15x4 mm Passo - Pitch 19 mm	15x4 mm Passo - Pitch 19 mm
Dimensioni in mm Dimensions mm	A	190	280	420
	B	135	135	135
	C	74	74	74
N° fori per barra Holes number each bar		6 x M5	11 x M5	17 x M5
Numero viti e rondelle incluse Included screws and washer		20 x M5	40 x M5	60 x M5
Distanza fra i supporti Distance between supports		114 mm	209 mm	171-171 mm
Potenza dissipata per barra Dissipated power for bar		0.96 W	1.77 W	2.89 W
I_{pk}	kA	48	30	40
$I_{cc\ rms}$	kA	23	15	20
$I_{cw\ mstS}$	kA	5	5	5
U_i	V	500	500	500
U_{imp}	kV	6	6	6

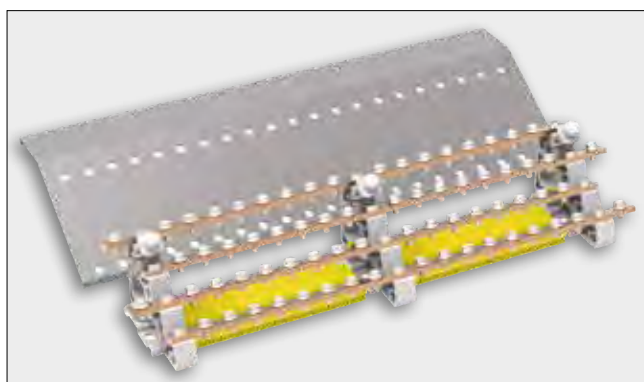

I ripartitori sono forniti completi di viti, profilo di protezione per guida DIN e coperchio

The distribution frames are supplied complete with screws, DIN rail protection profile and cover

Ripartitori quadripolari versione a Scaletta Quadripolar distribution frames Ladder version **250A** passo - pitch **19**

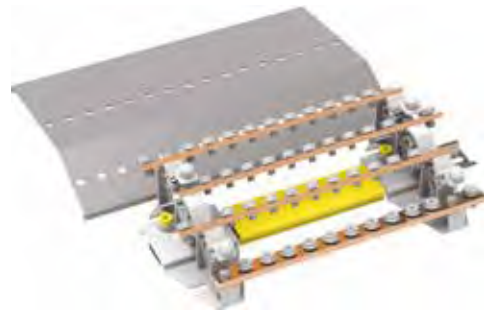
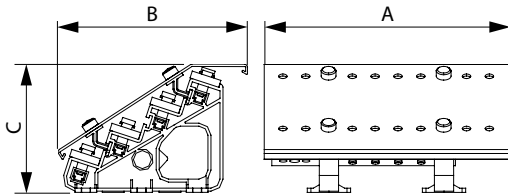

Articolo Item		BBD2506	BBD25011	BBD25017	BBD25027
Corrente nominale Rated current		250A	250A	250A	250A
Sezione barra e passo fori Bar section and holes pitch		20x5 mm Passo - Pitch 19 mm	20x5 mm Passo - Pitch 19 mm	20x5 mm Passo - Pitch 19 mm	20x5 mm Passo - Pitch 19 mm
Dimensioni in mm Dimensions mm	A	190	280	420	630
	B	190	190	190	190
	C	67	67	67	67
N° fori per barra Holes number each bar		6 fori - holes 1 x M8 - 5 x M6	11 fori - holes 1 x M8 - 10 x M6	17 fori - holes 1 x M8 - 16 x M6	27 fori - holes 1 x M8 - 26 x M6
Numero viti e rondelle incluse Included screws and washer		4 x M8 20 x M6	4 x M8 40 x M6	4 x M8 60 x M6	4 x M8 100 x M6
Distanza fra i supporti Distance between supports		114 mm	209 mm	171-171 mm	190-171-190 mm
Potenza dissipata per barra Dissipated power for bar		1.50 W	2.74 W	4.49 W	7.23 W
I_{pk}	kA	48	30	40	40
$I_{cc\ rms}$	kA	23	15	20	20
$I_{cw\ ms1S}$	kA	9	9	9	9
U_i	V	500	500	500	500
U_{imp}	kV	8	8	8	8

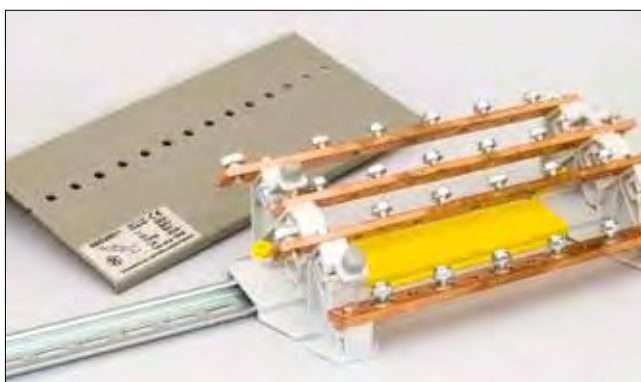

I ripartitori possono essere fissati su guida DIN con vite eccentrica o con viti usando le asole sulla base

The distribution frames can be fixed on DIN rail with eccentric screw or also with screws using the slot holes on the base

Ripartitori quadripolari versione a Scaletta

Quadripolar distribution frames Ladder version

400A passo - pitch 19

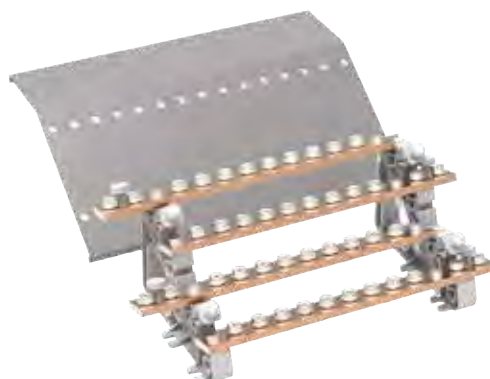
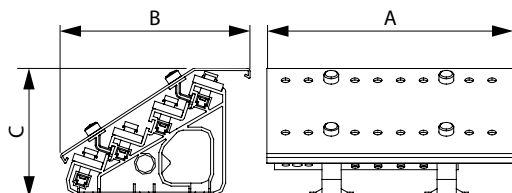

Articolo Item		BB4006	BB40011	BB40017	BB40027
Corrente nominale Rated current		400A	400A	400A	400A
Sezione barra e passo fori Bar section and holes pitch		25x6 mm Passo - Pitch 19 mm	25x6 mm Passo - Pitch 19 mm	25x6 mm Passo - Pitch 19 mm	25x6 mm Passo - Pitch 19 mm
Dimensioni in mm Dimensions mm	A	210	300	420	630
	B	175	175	175	175
	C	110	110	110	110
N° fori per barra Holes number each bar		6 fori - holes 1 x M8 - 5 x M6	11 fori - holes 1 x M8 - 10 x M6	17 fori - holes 1 x M8 - 16 x M6	27 fori - holes 1 x M8 - 26 x M6
Numero viti e rondelle incluse Included screws and washer		4 x M8 20 x M6	4 x M8 40 x M6	4 x M8 60 x M6	4 x M8 100 x M6
Distanza fra i supporti Distance between supports		95 mm	190 mm	152-152 mm	171-171-171 mm
Potenza dissipata per barra Dissipated power for bar		2.83 W	5.18 W	8.48 W	13.66 W
I_{pk}	kA	52	30	48	40
$I_{cc\ rms}$	kA	25	15	23	20
$I_{cw\ ms1S}$	kA	14	14	14	14
U_i	V	500	500	500	500
U_{imp}	kV	8	8	8	8



I ripartitori da 400A passo 19 mm possono essere fissati soltanto con viti, usando le asole sulla base

The distribution frames of 400A pitch 19 mm can be fixed only with screws, using the slotted holes on the base

Ripartitori quadripolari versione a Scaletta

Quadripolar distribution frames Ladder version

250A passo - pitch **25**

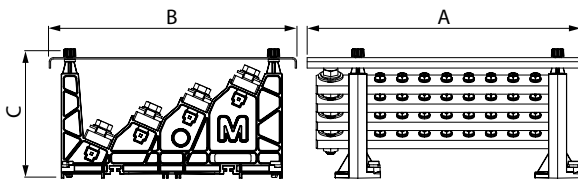

Articolo Item		BBD25509	BBD25512	BBD25515	BBD25518
Corrente nominale Rated current		250A	250A	250A	250A
Sezione barra e passo fori Bar section and holes pitch		20x5 mm Passo - Pitch 25 mm	20x5 mm Passo - Pitch 25 mm	20x5 mm Passo - Pitch 25 mm	20x5 mm Passo - Pitch 25 mm
Dimensioni in mm Dimensions mm	A	294	368	465	540
	B	190	190	190	190
	C	67	67	67	67
N° fori per barra Holes number each bar		9 fori - holes 1 x M8 - 8 x M6	12 fori - holes 1 x M8 - 11 x M6	15 fori - holes 1 x M8 - 14 x M6	18 fori - holes 1 x M8 - 17 x M6
Numero viti e rondelle incluse Included screws and washer		4 x M10 20 x M6	4 x M10 40 x M6	4 x M10 60 x M6	4 x M10 100 x M6
Distanza fra i supporti Distance between supports		220 mm	294 mm	196+196 mm	294+294 mm
Potenza dissipata per barra Dissipated power for bar		2.74 W	3.00 W	4.70 W	6.90 W
I_{pk}	kA	30	30	40	30
$I_{cc\ rms}$	kA	15	15	20	15
$I_{cw\ ms1s}$	kA	9	9	9	9
U_i	V	500	500	500	500
U_{imp}	kV	8	8	8	8

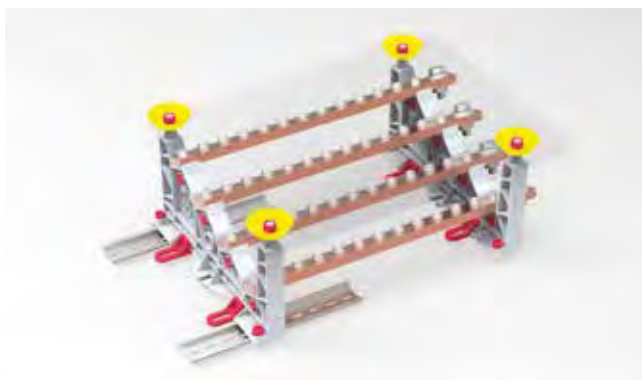

Per non danneggiare i ripartitori durante il trasporto, vengono inserite 4 protezioni in plastica gialla, che dovranno essere rimosse prima dell'installazione

In order not to damage the distributors frames during transport, 4 yellow plastic protections are inserted, which must be removed before installation

Ripartitori quadripolari versione a Scaletta

Quadripolar distribution frames Ladder version

400A passo - pitch 25

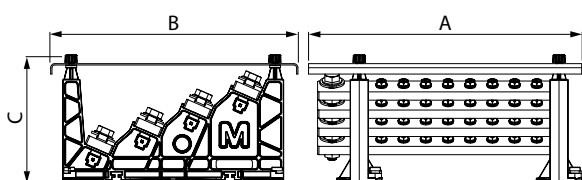

Articolo Item		BBD40009	BBD40012	BBD40015	BBD40018
Corrente nominale Rated current		400A	400A	400A	400A
Sezione barra e passo fori Bar section and holes pitch		30x5 mm Passo - Pitch 25 mm	30x5 mm Passo - Pitch 25 mm	30x5 mm Passo - Pitch 25 mm	30x5 mm Passo - Pitch 25 mm
Dimensioni in mm Dimensions mm	A	294	368	441	515
	B	275	275	275	275
	C	145	145	145	145
N° fori per barra Holes number each bar		9 fori - holes 1 x Ø 10,5 - 8 x M6	12 fori - holes 1 x Ø 10,5 - 11 x M6	15 fori - holes 1 x Ø 10,5 - 14 x M6	18 fori - holes 1 x Ø 10,5 - 17 x M6
Numero viti e rondelle incluse Included screws and washer		4 x M10 20 x M6	4 x M10 40 x M6	4 x M10 60 x M6	4 x M10 100 x M6
Distanza fra i supporti Distance between supports		220 mm	294 mm	367 mm	441 mm
Potenza dissipata per barra Dissipated power for bar		7.00 W	9.18 W	11.29 W	13.40 W
I_{pk}	kA	60	50	40	60
$I_{cc\ rms}$	kA	15	16	13	15
$I_{cw\ ms1S}$	kA	15	15	15	15
U_i	V	1000	1000	1000	1000
U_{imp}	kV	12	12	12	12



Per non danneggiare i ripartitori durante il trasporto, vengono inserite 4 protezioni in plastica gialla, che dovranno essere rimosse prima dell'installazione

In order not to damage the distributors frames during transport, 4 yellow plastic protections are inserted, which must be removed before installation

Ripartitori quadripolari con barre a foratura disassata versione a Scaletta

Quadripolar distribution frames Ladder version with offset drilling bars

400A passo - pitch **25x2**



Articolo Item		BDD40016	BDD40022
Corrente nominale Rated current		400A	400A
Sezione barra e passo fori Bar section and holes pitch		30x5 mm Passo - Pitch 25 mm	30x5 mm Passo - Pitch 25 mm
Dimensioni in mm Dimensions mm	A	294	368
	B	275	275
	C	145	145
N° fori per barra Holes number each bar		16 fori - holes 1 x Ø 10,5 - 15 x M6	22 fori - holes 1 x Ø 10,5 - 21 x M6
Numero viti e rondelle incluse Included screws and washer		4 x M10 20 x M6	4 x M10 40 x M6
Distanza fra i supporti Distance between supports		220 mm	294 mm
Potenza dissipata per barra Dissipated power for bar		7.00 W	9.18 W
I_{pk}	kA	60	50
$I_{cc\ rms}$	kA	15	16
$I_{cw\ ms1s}$	kA	15	15
U_i	V	1000	1000
U_{imp}	kV	12	12



I ripartitori con foratura disassata hanno più fori in uno spazio minore

Distribution frames with offset drilling have more holes in a smaller space

Ripartitori quadripolari versione a Scaletta
Quadripolar distribution frames Ladder version
630A passo - pitch **25**

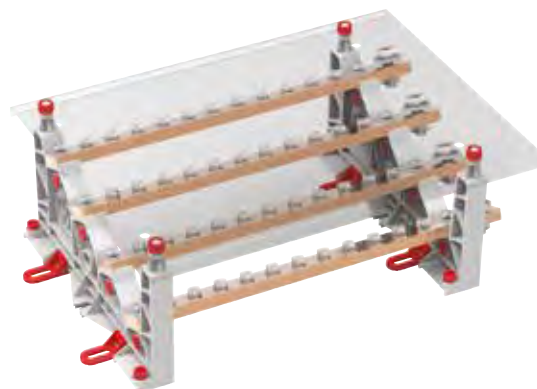
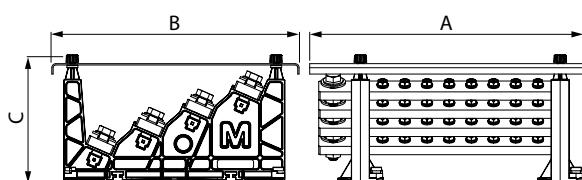

Articolo Item		BBD63009	BBD63012	BBD63015	BBD63018
Corrente nominale Rated current		630A	630A	630A	630A
Sezione barra e passo fori Bar section and holes pitch		30x10 mm Passo - Pitch 25 mm	30x10 mm Passo - Pitch 25 mm	30x10 mm Passo - Pitch 25 mm	30x10 mm Passo - Pitch 25 mm
Dimensioni in mm Dimensions mm	A	294	368	441	515
	B	275	275	275	275
	C	145	145	145	145
N° fori per barra Holes number each bar		9 fori - holes 1 x Ø 10,5 - 8 x M6	12 fori - holes 1 x Ø 10,5 - 11 x M6	15 fori - holes 1 x Ø 10,5 - 14 x M6	18 fori - holes 1 x Ø 10,5 - 17 x M6
Numero viti e rondelle incluse Included screws and washer		4 x M10 20 x M6	4 x M10 40 x M6	4 x M10 60 x M6	4 x M10 100 x M6
Distanza fra i supporti Distance between supports		220 mm	294 mm	367 mm	441 mm
Potenza dissipata per barra Dissipated power for bar		8.75 W	11.40 W	14.00 W	16.60 W
I_{pk}	kA	75	66	57	47
$I_{cc\ rms}$	kA	29	20	17	23
$I_{cw\ ms1S}$	kA	29	29	29	29
U_i	V	1000	1000	1000	1000
U_{imp}	kV	12	12	12	12

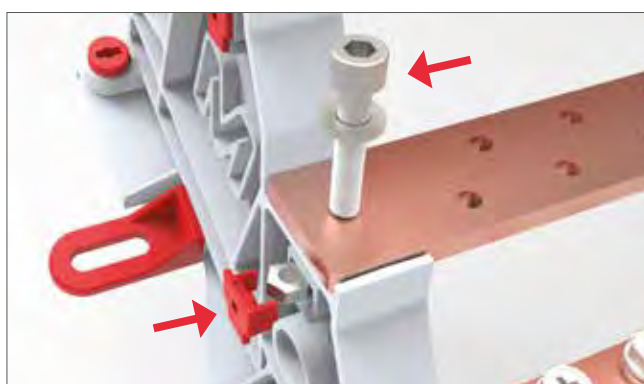

Le barre in RAME sono fissate con VITI e DADI in acciaio, il dado che viene inserito lateralmente è protetto con un tappo rosso in plastica

The COPPER bars are fixed with steel SCREWS and NUTS, the nut that is inserted laterally is protected with a red plastic cap

Ripartitori quadripolari versione Piana

Quadripolar distribution frames Flat version

160A passo - pitch 19

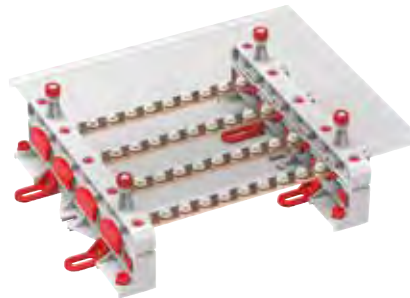
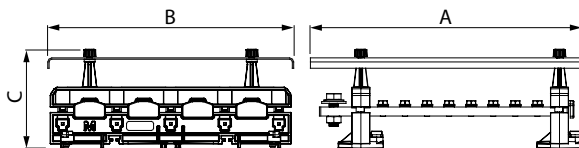

Articolo Item		BBS16006	BBS16011	BBS16017
Corrente nominale Rated current		160A	160A	160A
Sezione barra e passo fori Bar section and holes pitch		15x4 mm Passo - Pitch 19 mm	15x4 mm Passo - Pitch 19 mm	15x4 mm Passo - Pitch 19 mm
Dimensioni in mm Dimensions mm	A	190	280	420
	B	250	250	250
	C	95	95	95
N° fori per barra Holes number each bar		6 x M5	11 x M5	17 x M5
Numero viti e rondelle incluse Included screws and washer		20 x M5	40 x M5	60 x M5
Distanza fra i supporti Distance between supports		114 mm	209 mm	171-171 mm
Potenza dissipata per barra Dissipated power for bar		0.96 W	1.77 W	2.89 W
I_{pk}	kA	64	56	60
$I_{cc\ rms}$	kA	8	6	7
$I_{cw\ ms1s}$	kA	6	6	6
U_i	V	1000	1000	1000
U_{imp}	kV	12	12	12



La forma ergonomica dei dadi permette un serraggio rapido del coperchio

The ergonomic shape of the nuts allows for quick tightening of the cover

Ripartitori quadripolari versione Piana

Quadripolar distribution frames Flat version

250A passo - pitch 19

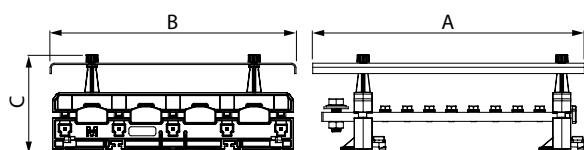

Articolo Item		BBS25006	BBS25011	BBS25017	BBS25027
Corrente nominale Rated current		250A	250A	250A	250A
Sezione barra e passo fori Bar section and holes pitch		20x5 mm Passo - Pitch 19 mm	20x5 mm Passo - Pitch 19 mm	20x5 mm Passo - Pitch 19 mm	20x5 mm Passo - Pitch 19 mm
Dimensioni in mm Dimensions mm	A	190	280	420	630
	B	250	250	250	250
	C	95	95	95	95
N° fori per barra Holes number each bar		6 fori - holes 1 x M8 - 5 x M6	11 fori - holes 1 x M8 - 10 x M6	17 fori - holes 1 x M8 - 16 x M6	27 fori - holes 1 x M8 - 26 x M6
Numero viti e rondelle incluse Included screws and washer		4 x M8 20 x M6	4 x M8 40 x M6	4 x M8 60 x M6	4 x M8 100 x M6
Distanza fra i supporti Distance between supports		114 mm	209 mm	171-171 mm	190-171-190 mm
Potenza dissipata per barra Dissipated power for bar		1.50 W	2.74 W	4.49 W	7.23 W
I_{pk}	kA	69	60	61	61
$I_{cc\ rms}$	kA	9	9	8	8
$I_{cw\ ms1S}$	kA	9	9	9	9
U_i	V	1000	1000	1000	1000
U_{imp}	kV	12	12	12	12

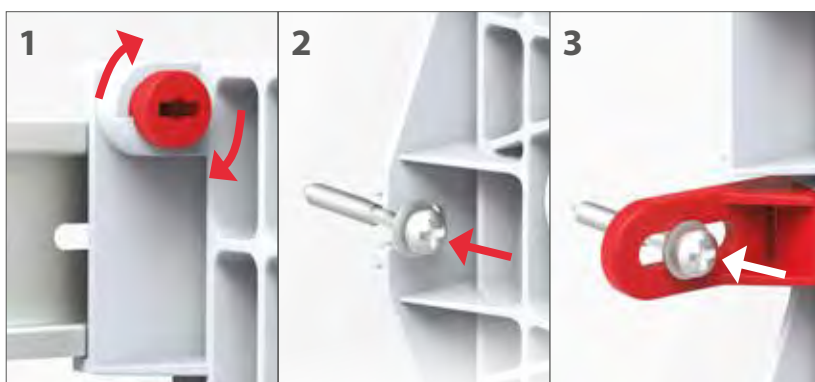

I ripartitori possono essere fissati:
1. Su guida DIN con perno eccentrico
2. Vite autofilettante usando le asole sulla base
3. Vite autofilettante usando i piedini rossi

The distribution frames can be fixed:
1. On rail with eccentric screw
2. Self-threading screws using the slot holes on the base
3. Self-threading screws using the red feet

Ripartitori quadripolari versione Piana

Quadripolar distribution frames Flat version

400A passo - pitch 19

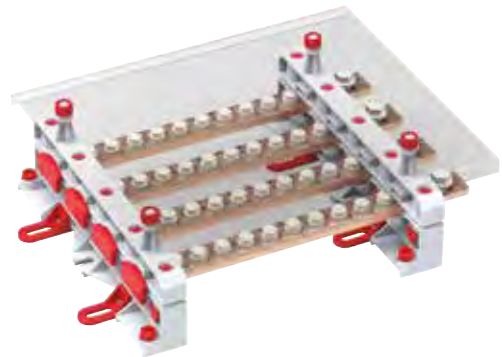
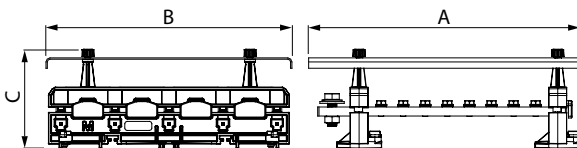

Articolo Item		BBS41906	BBS41911	BBS41917	BBS41927
Corrente nominale Rated current		400A	400A	400A	400A
Sezione barra e passo fori Bar section and holes pitch		25x6 mm Passo - Pitch 19 mm	25x6 mm Passo - Pitch 19 mm	25x6 mm Passo - Pitch 19 mm	25x6 mm Passo - Pitch 19 mm
Dimensioni in mm Dimensions mm	A	210	300	420	630
	B	250	250	250	250
	C	95	95	95	95
N° fori per barra Holes number each bar		6 fori - holes 1 x M8 - 5 x M6	11 fori - holes 1 x M8 - 10 x M6	17 fori - holes 1 x M8 - 16 x M6	18 fori - holes 1 x M8 - 26 x M6
Numero viti e rondelle incluse Included screws and washer		4 x M10 20 x M6	4 x M10 40 x M6	4 x M10 60 x M6	4 x M10 100 x M6
Distanza fra i supporti Distance between supports		95 mm	190 mm	152+152 mm	171+171+171 mm
Potenza dissipata per barra Dissipated power for bar		2.83 W	5.18 W	8.48 W	13.66 W
I_{pk}	kA	85	72	79	72
$I_{cc\ ms}$	kA	11	15	10	10
$I_{cw\ ms1s}$	kA	14	14	14	14
U_i	V	1000	1000	1000	1000
U_{imp}	kV	12	12	12	12

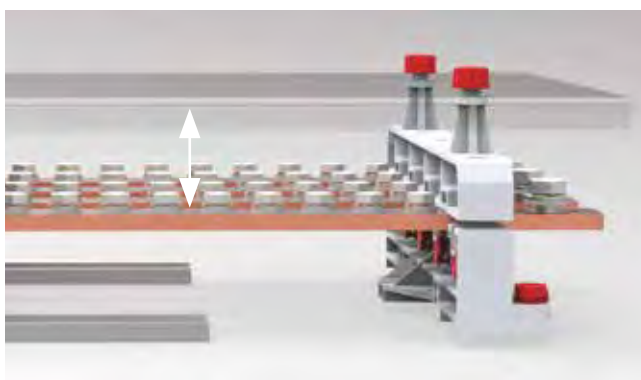

Nella versione PIANA la distanza delle barre dal coperchio è maggiorata per facilitare il cablaggio con l'utilizzo dei terminali piegati

In the FLAT version, the distance of the bars from the cover is increased to facilitate wiring with the use of bent terminals

Ripartitori quadripolari versione Piana
Quadripolar distribution frames Flat version
250A passo - pitch **25**

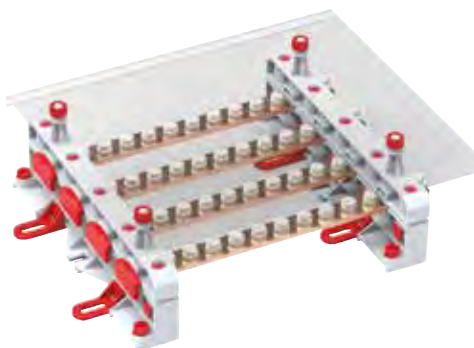
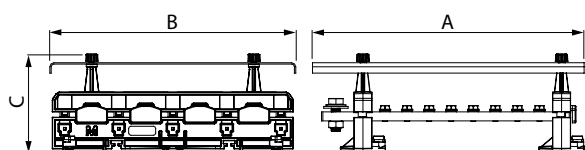

Articolo Item		BBS25509	BBS25512	BBS25515	BBS25518
Corrente nominale Rated current		250A	250A	250A	250A
Sezione barra e passo fori Bar section and holes pitch		20x5 mm Passo - Pitch 25 mm	20x5 mm Passo - Pitch 25 mm	20x5 mm Passo - Pitch 25 mm	20x5 mm Passo - Pitch 25 mm
Dimensioni in mm Dimensions mm	A	294	368	465	540
	B	275	275	275	275
	C	95	95	95	95
N° fori per barra Holes number each bar		9 fori - holes 1 x M8 - 8 x M6	12 fori - holes 1 x M8 - 11 x M6	15 fori - holes 1 x M8 - 14 x M6	18 fori - holes 1 x M8 - 17 x M6
Numero viti e rondelle incluse Included screws and washer		4 x M10 20 x M6	4 x M10 40 x M6	4 x M10 60 x M6	4 x M10 100 x M6
Distanza fra i supporti Distance between supports		220 mm	294 mm	196+196 mm	294+294 mm
Potenza dissipata per barra Dissipated power for bar		1.92 W	3.00 W	4.70 W	6.90 W
I_{pk}	kA	54	47	61	54
$I_{cc\ rms}$	kA	9	7	8	9
$I_{cw\ ms1s}$	kA	9	9	9	9
U_i	V	1000	1000	1000	1000
U_{imp}	kV	12	12	12	12

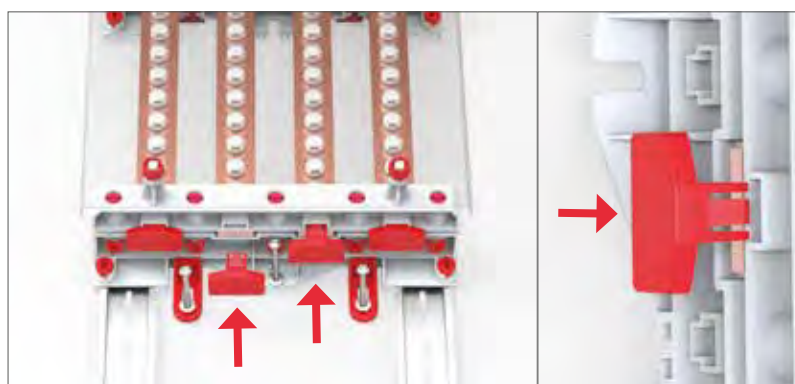

Lateralmente le barre in RAME sono protette con dei tappi in plastica rossa

On the side the COPPER bars are protected with red plastic caps

Ripartitori quadripolari versione Piana

Quadripolar distribution frames Flat version

400A passo - pitch 25

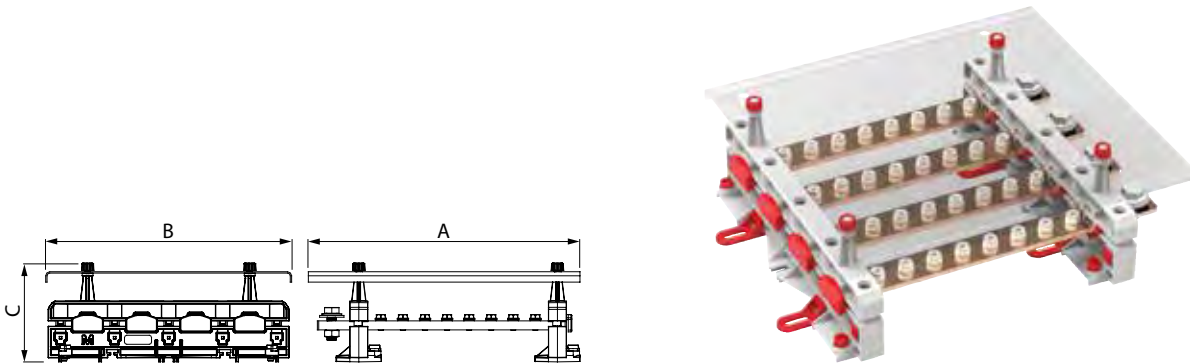

Articolo Item		BBS40009	BBS40012	BBS40015	BBS40018
Corrente nominale Rated current		400A	400A	400A	400A
Sezione barra e passo fori Bar section and holes pitch		30x5 mm Passo - Pitch 25 mm	30x5 mm Passo - Pitch 25 mm	30x5 mm Passo - Pitch 25 mm	30x5 mm Passo - Pitch 25 mm
Dimensioni in mm Dimensions mm	A	294	368	441	515
	B	275	275	275	275
	C	110	110	110	110
N° fori per barra Holes number each bar		9 fori - holes 1 x Ø 10,5 - 8 x M6	12 fori - holes 1 x Ø 10,5 - 11 x M6	15 fori - holes 1 x Ø 10,5 - 14 x M6	18 fori - holes 1 x Ø 10,5 - 17 x M6
Numero viti e rondelle incluse Included screws and washer		4 x M10 20 x M6	4 x M10 40 x M6	4 x M10 60 x M6	4 x M10 100 x M6
Distanza fra i supporti Distance between supports		220 mm	294 mm	367 mm	441 mm
Potenza dissipata per barra Dissipated power for bar		7.00 W	9.18 W	11.29 W	13.40 W
I_{pk}	kA	52	46	42	41
$I_{cc\ rms}$	kA	7	16	7	6
$I_{cw\ ms1s}$	kA	15	15	15	15
U_i	V	1000	1000	1000	1000
U_{imp}	kV	12	12	12	12

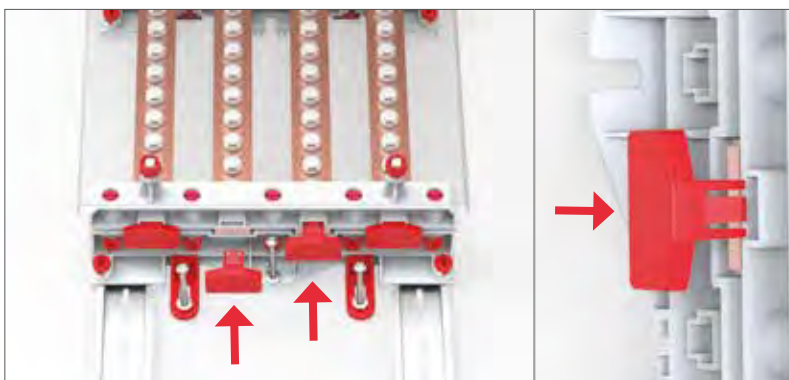

Lateralmente le barre in RAME sono protette con dei tappi in plastica rossa

On the side the COPPER bars are protected with red plastic caps

Ripartitori quadripolari versione Piana
Quadripolar distribution frames Flat version
630A passo - pitch **25**

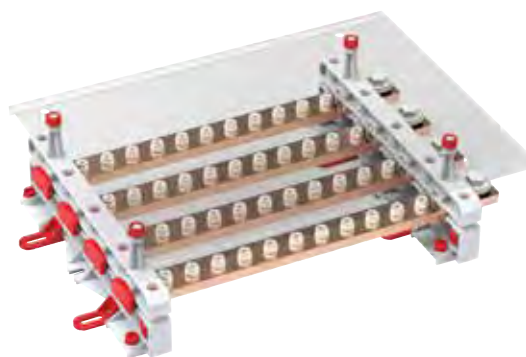
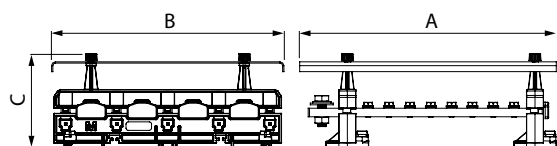

Articolo Item		BBS63009	BBS63012	BBS63015	BBS63018
Corrente nominale Rated current		630A	630A	630A	630A
Sezione barra e passo fori Bar section and holes pitch		30x10 mm Passo - Pitch 25 mm	30x10 mm Passo - Pitch 25 mm	30x10 mm Passo - Pitch 25 mm	30x10 mm Passo - Pitch 25 mm
Dimensioni in mm Dimensions mm	A	294	368	441	515
	B	275	275	275	275
	C	110	110	110	110
N° fori per barra Holes number each bar		9 fori - holes 1 x Ø 10,5 - 8 x M6	12 fori - holes 1 x Ø 10,5 - 11 x M6	15 fori - holes 1 x Ø 10,5 - 14 x M6	18 fori - holes 1 x Ø 10,5 - 17 x M6
Numero viti e rondelle incluse Included screws and washer		4 x M10 20 x M6	4 x M10 40 x M6	4 x M10 60 x M6	4 x M10 100 x M6
Distanza fra i supporti Distance between supports		220 mm	294 mm	367 mm	441 mm
Potenza dissipata per barra Dissipated power for bar		8.75 W	11.40 W	14.00 W	16.60 W
I_{pk}	kA	86	78	71	62
$I_{cc\ rms}$	kA	12	10	10	29
$I_{cw\ ms1S}$	kA	29	29	29	29
U_i	V	1000	1000	1000	1000
U_{imp}	kV	12	12	12	12



Per il collegamento dell'alimentazione vengono fornite VITI con DOPPIA RONDELLA

SCREWS with DOUBLE WASHER are supplied for connecting the power supply

Ripartitori quadripolari con barre a foratura disassata versione Piana
 Quadripolar distribution frames Flat version with offset drilling bars

400A passo - pitch **25x2**

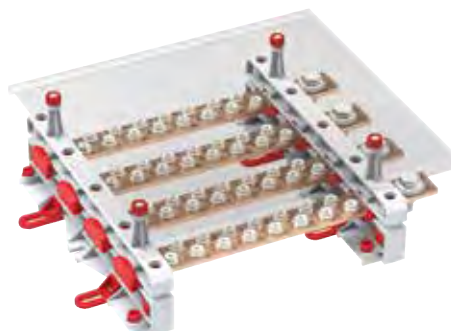

Articolo Item		BDS40016	BDS40022
Corrente nominale Rated current		400A	400A
Sezione barra e passo fori Bar section and holes pitch		30x5 mm Passo - Pitch 25 mm	30x5 mm Passo - Pitch 25 mm
Dimensioni in mm Dimensions mm	A	294	368
	B	275	275
	C	110	110
N° fori per barra Holes number each bar		16 fori - holes 1 x Ø 10,5 - 15x M6	22 fori - holes 1 x Ø 10,5 - 21 x M6
Numero viti e rondelle incluse Included screws and washer		4 x M10 60 x M6	4 x M10 100 x M6
Distanza fra i supporti Distance between supports		220 mm	294 mm
Potenza dissipata per barra Dissipated power for bar		7.00 W	9.18 W
I_{pk}	kA	52	46
$I_{cc\ ms}$	kA	7	16
$I_{cw\ ms1s}$	kA	15	15
U_i	V	1000	1000
U_{imp}	kV	12	12

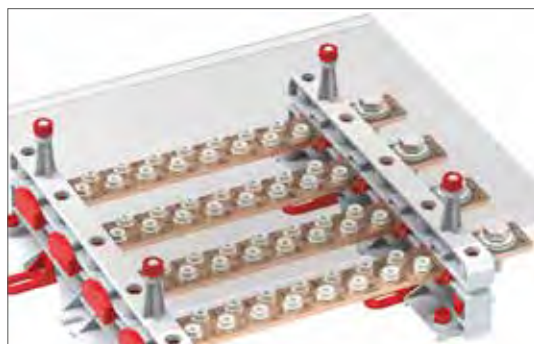

I ripartitori con foratura disassata hanno più fori in uno spazio minore

Distribution frames with offset drilling have more holes in a smaller space

BOXLINE morsetti unipolari multiforo BOXLINE unipolar terminal blocks multi-holes

<p>Certificazioni: IMQ Conformità: CE, RoHS 2015/863/EU Normative: EN 60998-1:2004 Temperatura d'esercizio: -5°C +85°C Resistenza al calore: 130°C Certifications: IMQ Compliance: CE, RoHS 2015/863/EU Standards: EN 60998-1: 2004 Working temperature: -5°C +85°C Heat resistance: 130°C</p>		<p>Materiale guscio: Poliammide/Polycarbonato Materiale Inserto: Ottone Shell material: Polyamide/Polycarbonate Insert material: Brass</p>
		

Articolo Item	Colore Color	Nr. fori Nr. holes	Dimensioni fori Holes dimension	Tensione Nominale Rated voltage	Grado di protezione Protection degree	Conduttori connettibili Connectable cables	Dimensioni Dimensions				
							A mm	B mm	C mm	ØD1 mm	ØD2 mm
507F	Grigio - Grey	7	2xØ6 mm 5xØ5,3 mm	750 V	IP00	2x16 mm ² 5x10 mm ²	19	59	34	6	5,3
507N	Blu - Blue										
T167	Verde - Green										
5011F	Grigio - Grey	11	2xØ6 mm 9xØ5,3 mm	750 V	IP00	2x16 mm ² 9x10 mm ²	19	88	34	6	5,3
5011N	Blu - Blue										
T1611	Verde - Green										
5015F	Grigio - Grey	15	2xØ6 mm 13xØ5,3 mm	750 V	IP00	2x16 mm ² 13x10 mm ²	19	114	34	6	5,3
5015N	Blu - Blue										
T1615	Verde - Green										

BOXDIS morsetti di ripartizione per quadri elettrici BOXDIS distribution terminal blocks for electrical panels

<p>Certificazioni: VDE Conformità: CE, RoHS 2015/863/EU Normative: EN 60998-1:2004 Temperatura d'esercizio: -5°C +85°C Resistenza al calore: 130°C Certifications: VDE Compliance: CE, RoHS 2015/863/EU Standards: EN 60998-1: 2004 Working temperature: -5°C +85°C Heat resistance: 130°C</p>		<p>Materiale guscio: Poliammide Materiale Inserto: Ottone Shell material: Polyamide Insert material: Brass</p>
		

Articolo Item	Corrente nominale Rated current	Numero poli Number poles	N. fori per polo N. holes for pole	Dimensione fori Dimension holes	Sezione fori Holes cross section	Coppia serraggio Tightening torque	Colore Colour	Dimensioni Dimensions		
								Nm	A mm	B mm
BKB251	100 A	1	2 + 2	2 x Ø6 mm 2 x Ø6,6 mm	16/25 mm ²	2,5	Grigio Grey	24	43	37
BKB251V	100 A	1	2 + 2	2 x Ø6 mm 2 x Ø6,6 mm	16/25 mm ²	2,5	Verde Green	24	43	37
BKB251N	100 A	1	2 + 2	2 x Ø6 mm 2 x Ø6,6 mm	16/25 mm ²	2,5	Blu Blue	24	43	37
BKB253	100 A	3	2 + 2	2 x Ø6 mm 2 x Ø6,6 mm	16/25 mm ²	2,5	Grigio Grey	61	43	37
BKB254	100 A	4	2 + 2	2 x Ø6 mm 2 x Ø6,6 mm	16/25 mm ²	2,5	Grigio Grey	83	43	37

BOXDIS morsettiere di ripartizione per quadri elettrici BOXDIS distribution terminal blocks for electrical panels

<p>Conformità: CE, RoHS 2015/863/EU Normative: EN 60998-1:2004 Temperatura d'esercizio: -5°C +85°C Resistenza al calore: 130°C Compliance: CE, RoHS 2015/863/EU Standards: EN 60998-1: 2004 Working temperature: -5°C +85°C Heat resistance: 130°C</p>						<p>Materiale guscio: Poliammide/Polycarbonato Materiale Inserto: Ottone Shell material: Polyamide/Polycarbonate Insert material: Brass</p>					
Articolo Item	Corrente nominale Rated current	Numero poli Number poles	Nr. fori per polo Nr. holes each pole	Dimensione fori Dimension holes	Sezione fori Max section for bar	Coppia serraggio Tightening torque	I_{pk}	I_{cw}	Dimensioni Dimensions		
						Nm			kA	kA	A mm
BKB0807	80 A	1	7	3 x Ø6,8 mm 4 x Ø4,5 mm	3 x 16 mm ² 4 x 6 mm ²	3,5 1,2	22	3	27	66	46
BKB12508	125 A	1	8	1 x Ø10 mm 7 x Ø6,8 mm	1 x 35 mm ² 7 x 16 mm ²	8,5 3,5	30	4,2	29	77	46
BKB16008	160 A	1	8	1 x Ø12,3 mm 7 x Ø6,8 mm	1 x 70 mm ² 7 x 16 mm ²	8,5 3,5	30	11,8	29	77	46
BKB25012	250 A	1	12	1 x Ø15 mm 2 x Ø9 mm 5 x Ø7 mm 4 x Ø6 mm	1 x 120 mm ² 2 x 35 mm ² 5 x 16 mm ² 4 x 10 mm ²	19 4,4 2,7 2,7	51	24,5	46	96	50
BKB40012	400 A	1	12	1 x Ø19 mm 2 x Ø9 mm 5 x Ø7 mm 4 x Ø6 mm	1 x 185 mm ² 2 x 35 mm ² 5 x 16 mm ² 4 x 10 mm ²	25 4,4 2,7 2,7	51	24,5	46	96	50
BKB50012	500 A	1	12	8 x 24 mm 2 x Ø9 mm 5 x Ø7 mm 4 x Ø6 mm	Flexible busbar 2 x 35 mm ² 5 x 16 mm ² 4 x 10 mm ²	10 4,4 2,7 2,7	51	24,5	46	96	50

BOXDIS morsettiere di ripartizione per quadri elettrici BOXDIS distribution terminal blocks for electrical panels

<p>Certificazioni: IMO Conformità: CE, RoHS 2015/863/EU Normative: EN 60998-1:2004 Temperatura d'esercizio: -5°C +85°C Resistenza al calore: 130°C Certifications: IMO Compliance: CE, RoHS 2015/863/EU Standards: EN 60998-1: 2004 Working temperature: -5°C +85°C Heat resistance: 130°C</p>						<p>Materiale guscio: Poliammide Materiale Inserto: Ottone Shell material: Polyamide Insert material: Brass</p>							
Articolo Item	Corrente nominale Rated current	Numero poli Number poles	N. fori per polo N. holes for pole	Dimensione fori Dimension holes	Sezione fori Max section for bar	Coppia serraggio Tightening torque	I_{pk}	I_{cw}	I_{cc}	U_{imp}	Dimensioni Dimensions		
						Nm					kA	kA	kV
BKB12511	125 A	1	11	1 x Ø9 mm 2 x Ø7 mm 8 x Ø5,5 mm	1 x 35 mm ² 2 x 25 mm ² 8 x 10 mm ²	4,4 - 2,7	20	6	10	8	35	43	45
BKB16011	160 A	1	11	1 x Ø12 mm 2 x Ø9 mm 8 x Ø7 mm	1 x 50 mm ² 2 x 35 mm ² 8 x 16 mm ²	- 4,4 2,7	24	10	12	8	40	43	45

BOXDIS morsetti unipolari a 1 foro, fissaggio a scatto su guida DIN BOXDIS 1 hole unipolar terminals, DIN rail easy click fixing

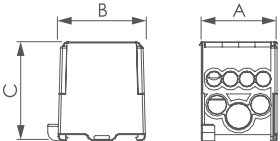
<p>Conformità: CE, RoHS, REACH Normative: EN 60947-7-1 Temperatura d'esercizio: -10°C +85°C Resistenza al calore: 130°C Compliance: CE, RoHS, REACH Standards: EN 60947-7-1 Working temperature: -10°C +85°C Heat resistance: 130°C</p>							<p>Materiale guscio: Poliammide Materiale Inserto: Alluminio nichelato Shell material: Polyamide Insert material: Tin-Coated Aluminum</p>			
										
Articolo Item	Corrente nominale Rated current	Voltage		Viti Screws	Colore Color	Sezione fori Max section for bar	Coppia serraggio Tightening torque	Dimensioni Dimensions		
		AC	DC				Nm	A mm	B mm	C mm
BKF161G	Cu 85A Al 85A	1000V	1500V	M4	Grigio Grey	Cu 1,5x16 mm ² Al 1,5x16 mm ²	1,5 3,5 7	13,9	43,5	40
BKF161B	Cu 85A Al 85A	1000V	1500V	M4	Blu Blue	Cu 1,5x16 mm ² Al 1,5x16 mm ²	1,5 3,5 7	13,9	43,5	40
BKF161V	Cu 85A Al 85A	1000V	1500V	M4	Verde/Giallo Green/Yellow	Cu 1,5x16 mm ² Al 1,5x16 mm ²	1,5 3,5 7	13,9	43,5	40
BKF351G	Cu 135A Al 120A	1000V	1500V	M4	Grigio Grey	Cu 2,5x16 mm ² Al 2,5x16 mm ²	3 6	16,3	47,4	40
BKF351B	Cu 135A Al 120A	1000V	1500V	M4	Blu Blue	Cu 2,5x16 mm ² Al 2,5x16 mm ²	3 6	16,3	47,4	40
BKF351V	Cu 135A Al 120A	1000V	1500V	M4	Verde/Giallo Green/Yellow	Cu 2,5x16 mm ² Al 2,5x16 mm ²	3 6	16,3	47,4	40
BKF501G	Cu 160A Al 145A	1000V	1500V	M5	Grigio Grey	Cu 2,5x50 mm ² Al 6x50 mm ²	4 12	17,9	51	43,7
BKF501B	Cu 160A Al 145A	1000V	1500V	M5	Blu Blue	Cu 2,5x50 mm ² Al 6x50 mm ²	4 12	17,9	51	43,7
BKF501V	Cu 160A Al 145A	1000V	1500V	M5	Verde/Giallo Green/Yellow	Cu 2,5x50 mm ² Al 6x50 mm ²	4 12	17,9	51	43,7
BKF951G	Cu 245A Al 220A	1000V	1500V	M5	Grigio Grey	Cu 16x95 mm ² Al 16x95 mm ²	20	23,7	89	49,6
BKF951B	Cu 245A Al 220A	1000V	1500V	M5	Blu Blue	Cu 16x95 mm ² Al 16x95 mm ²	20	23,7	89	49,6
BKF951V	Cu 245A Al 220A	1000V	1500V	M5	Verde/Giallo Green/Yellow	Cu 16x95 mm ² Al 16x95 mm ²	20	23,7	89	49,6
BKF1501G	Cu 320A Al 290A	1000V	1500V	M8	Grigio Grey	Cu 35x150 mm ² Al 35x150 mm ²	20 30	28,9	96,6	59,2
BKF1501B	Cu 320A Al 290A	1000V	1500V	M8	Blu Blue	Cu 35x150 mm ² Al 35x150 mm ²	20 30	28,9	96,6	59,2
BKF1501V	Cu 320A Al 290A	1000V	1500V	M8	Verde/Giallo Green/Yellow	Cu 35x150 mm ² Al 35x150 mm ²	20 30	28,9	96,6	59,2
BKF2401G	Cu 425A Al 380A	1000V	1500V	M8	Grigio Grey	Cu 35x240 mm ² Al 35x150 mm ²	12 45	36,6	130,6	67,2
BKF2401B	Cu 425A Al 380A	1000V	1500V	M8	Blu Blue	Cu 35x240 mm ² Al 35x150 mm ²	12 45	36,6	130,6	67,2
BKF2401V	Cu 425A Al 380A	1000V	1500V	M8	Verde/Giallo Green/Yellow	Cu 35x240 mm ² Al 35x150 mm ²	12 45	36,6	130,6	67,2

BOXDIS morsetti Unipolari a 2 fori, fissaggio a scatto su guida DIN BOXDIS 2 holes unipolar terminals, DIN rail easy click fixing

<p>Conformità: CE, RoHS, REACH Normative: EN 60947-7-1 Temperatura d'esercizio: -10°C +85°C Resistenza al calore: 130°C Compliance: CE, RoHS, REACH Standards: EN 60947-7-1 Working temperature: -10°C +85°C Heat resistance: 130°C</p>							<p>Materiale guscio: Poliammide Materiale Inserto: Alluminio nichelato Shell material: Polyamide Insert material: Tin-Coated Aluminum</p>				
Articolo Item	Corrente nominale Rated current	Voltaggio Voltage		Viti Screws	Colore Color	Sezione fori Max section for bar	Coppia serraggio Tightening torque		Dimensioni Dimensions		
		AC	DC				Nm	A mm	B mm	C mm	
BKF162G	Cu 85A Al 85A	1000V	1500V	M4	Grigio Grey	Cu 1,5x16 mm ² Al 1,5x16 mm ²	1,5 3,5 7	23,7	43,5	40	
BKF162B	Cu 85A Al 85A	1000V	1500V	M4	Blu Blue	Cu 1,5x16 mm ² Al 1,5x16 mm ²	1,5 3,5 7	23,7	43,5	40	
BKF162V	Cu 85A Al 85A	1000V	1500V	M4	Verde/Giallo Green/Yellow	Cu 1,5x16 mm ² Al 1,5x16 mm ²	1,5 3,5 7	23,7	43,5	40	
BKF352G	Cu 135A Al 120AA	1000V	1500V	M4	Grigio Grey	Cu 2,5x16 mm ² Al 2,5x16 mm ²	3 6	27,3	47,4	40	
BKF352B	Cu 135A Al 120A	1000V	1500V	M4	Blu Blue	Cu 2,5x16 mm ² Al 2,5x16 mm ²	3 6	27,3	47,4	40	
BKF352V	Cu 135A Al 120A	1000V	1500V	M4	Verde/Giallo Green/Yellow	Cu 2,5x16 mm ² Al 2,5x16 mm ²	3 6	27,3	47,4	40	
BKF502G	Cu 160A Al 145A	1000V	1500V	M5	Grigio Grey	Cu 2,5x50 mm ² Al 6x50 mm ²	4 12	17,9	51	43,7	
BKF502B	Cu 160A Al 145A	1000V	1500V	M5	Blu Blue	Cu 2,5x50 mm ² Al 6x50 mm ²	4 12	17,9	51	43,7	
BKF502V	Cu 160A Al 145A	1000V	1500V	M5	Verde/Giallo Green/Yellow	Cu 2,5x50 mm ² Al 6x50 mm ²	4 12	17,9	51	43,7	

BOXDIS morsetti Unipolari a 3 fori, fissaggio a scatto su guida DIN BOXDIS 3 holes unipolar terminals, DIN rail easy click fixing

<p>Conformità: CE, RoHS, REACH Normative: EN 60947-7-1 Temperatura d'esercizio: -10°C +85°C Resistenza al calore: 130°C Compliance: CE, RoHS, REACH Standards: EN 60947-7-1 Working temperature: -10°C +85°C Heat resistance: 130°C</p>							<p>Materiale guscio: Poliammide Materiale Inserto: Alluminio nichelato Shell material: Polyamide Insert material: Tin-Coated Aluminum</p>				
Articolo Item	Corrente nominale Rated current	Voltaggio Voltage		Viti Screws	Colore Color	Sezione fori Max section for bar	Coppia serraggio Tightening torque		Dimensioni Dimensions		
		AC	DC				Nm	A mm	B mm	C mm	
BKF503G	Cu 160A Al 145A	1000V	1500V	M5	Grigio Grey	Cu 2,5x50 mm ² Al 6x50 mm ²	4 Nm 12 Nm	50,3	49	43,5	
BKF503B	Cu 160A Al 145A	1000V	1500V	M5	Blu Blue	Cu 2,5x50 mm ² Al 6x50 mm ²	4 Nm 12 Nm	50,3	49	43,5	
BKF503V	Cu 160A Al 145A	1000V	1500V	M5	Verde/Giallo Green/Yellow	Cu 2,5x50 mm ² Al 6x50 mm ²	4 Nm 12 Nm	50,3	49	43,5	













Morsetti con serraggio a vite Screw clamp terminal blocks

Conformità: CE, RoHS 2015/863/EU Normative: IEC60947-7-1, UL1059, CSA22.2-158 Infiammabilità: UL94V0 Temperatura di esercizio: -40°C +80°C Resistenza al calore: 100°C				Compliance: CE, RoHS 2015/863/EU Standards: IEC60947-7-1, UL1059, CSA22.2-158 Flammability: UL94V0 Working temperature: -40°C +80°C Heat resistance: 100°C									
Immagine prodotto Product image													
Articolo Item	Grigio/Grey	CTS2.5UN	CTS4UN	CTS6U	CTS10U								
	Blu/Blue	CTS2.5UNBU	CTS4UNBU	CTS6UBU	CTS10UBU								
Schema di collegamento Connection diagram													
Dimensioni Dimensions	H x L x S	46.2 x 43 x 5 mm	46.2 x 43.0 x 6 mm	47.8 x 43.0 x 8 mm	47.8 x 43.0 x 10 mm								
Conduttori connettibili per foro Connection Possibility each hole	Flessibili Flexible	1 x 0.25 ÷ 2.5 mm ² 2 x 0.25 ÷ 1.5 mm ²	1 x 0.25 ÷ 4.0 mm ² 2 x 0.25 ÷ 2.5 mm ²	1 x 0.5 ÷ 6.0 mm ² 2 x 0.5 ÷ 4.0 mm ²	1 x 0.5 ÷ 10.0 mm ² 2 x 0.5 ÷ 6.0 mm ²								
	Rigidi Solid	1 x 0.25 ÷ 4.0 mm ²	1 x 0.25 ÷ 6.0 mm ²	-	-								
	Con terminale With ferrule/lug	1 x 0.25 ÷ 2.5 mm ² 2 x 0.25 ÷ 1.5 mm ²	1 x 0.25 ÷ 4.0 mm ² 2 x 0.25 ÷ 2.5 mm ²	1 x 0.5 ÷ 6.0 mm ² 2 x 0.5 ÷ 4.0 mm ²	1 x 0.5 ÷ 10.0 mm ² 2 x 0.5 ÷ 6.0 mm ²								
Lunghezza spelatura cavo Cable stripping length		8 mm	8 mm	9 mm	11 mm								
Materiale isolante Insulating material		Poliamide 6.6 Polyamide 6.6		Poliamide 6.6 Polyamide 6.6									
Normativa di riferimento Reference standard		IEC	UL	CSA	IEC	UL	CSA	IEC	UL	CSA	IEC	UL	CSA
Tensione nominale Voltage Rating		1000 V	600 V	600 V	1000 V	600 V	600 V	1000 V	600 V	600 V	1000 V	600 V	600 V
Corrente nominale Current Rating		24 A	25 A	25 A	32 A	35 A	35 A	41 A	50 A	50 A	57 A	65 A	65 A
Coppia di serraggio Tightening torque range		0.4 Nm	7 lb-in	7 lb-in	0.5 Nm	7 lb-in	7 lb-in	0.8 Nm	14 lb-in	14 lb-in	1,2 Nm	14 lb-in	14 lb-in
Certificazioni Certifications													
Terminale End plate		EP2.5/4UN			EP2.5/4UN			EP6/10U			EP6/10U		
Diaframma Partition plate		PP2.5/4UN			PP2.5/4UN			PP6/10U			PP6/10U		
Separatore Separator plate		SP2.5/4UN			SP2.5/4UN			SP6/10U			SP6/10U		
Blocchetto terminale a incastro Interlocking end clamp		CA702			CA702			CA702			CA702		
Blocchetto terminale a vite Screw end clamp		CA802			CA802			CA802			CA802		
Marcatore Marking tags		CA509/K5WHT			CA509/K6WHT			CA509/K8WHT			CA509/K10WHT		
Ponte di parallelo 2 poli Shorting links 2 poles		CA721/2 (Imax 24A)			CA722/2 (Imax 32A)			CA723/2 (Imax 41A)			CA724/2 (Imax 41A)		
Ponte di parallelo 3 poli Shorting links 3 poles		CA721/3 (Imax 24A)			CA722/3 (Imax 32A)			CA723/3 (Imax 41A)			CA724/3 (Imax 41A)		
Ponte di parallelo 4 poli Shorting links 4 poles		CA721/4 (Imax 24A)			CA722/4 (Imax 32A)			CA723/4 (Imax 41A)			CA724/4 (Imax 41A)		
Ponte di parallelo 10 poli Shorting links 10 poles		CA721/10 (Imax 24A)			CA722/10 (Imax 32A)			CA723/10 (Imax 41A)			CA724/10 (Imax 41A)		

Conformità: CE, RoHS 2015/863/EU Normative: IEC60947-7-1, UL1059, CSA22.2-158 Infiammabilità: UL94V0 Temperatura di esercizio: -40°C +80°C Resistenza al calore: 100°C	Compliance: CE, RoHS 2015/863/EU Standards: IEC60947-7-1, UL1059, CSA22.2-158 Flammability: UL94V0 Working temperature: -40°C +80°C Heat resistance: 100°C
---	---

CTS16U	CTS25UN	CTS35UN	CTS50/70N	CTS95/120N										
CTS16UBU	CTS25UNBU	CTS35UNBU	CTS50/70NBU	CTS95/120NBU										
47.8 x 43.0 x 12 mm	57.2 x 48 x 12 mm	59.2 x 50.5 x 16 mm	71.1 x 77 x 20.5 mm	83.0 x 85 x 27 mm										
1 x 2.5 ÷ 16 mm ² 2 x 2.5 ÷ 10 mm ²	1 x 4.0 ÷ 25.0 mm ² 2 x 4.0 ÷ 16.0 mm ²	1 x 4.0 ÷ 35.0 mm ² 2 x 4.0 ÷ 16.0 mm ²	1 x 10.0 ÷ 70.0 mm ² 2 x 4.0 ÷ 35.0 mm ²	1 x 25.0 ÷ 120.0 mm ² 2 x 10.0 ÷ 70.0 mm ²										
-	-	-	-	-										
1 x 0.2 ÷ 16 mm ² 2 x 0.2 ÷ 10 mm ²	1 x 4.0 ÷ 25.0 mm ² 2 x 4.0 ÷ 10.0 mm ²	1 x 4.0 ÷ 35.0 mm ² 2 x 4.0 ÷ 16.0 mm ²	1 x 10.0 ÷ 70.0 mm ²	1 x 25.0 ÷ 120.0 mm ²										
12 mm	14 mm	15 mm	22 mm	24 mm										
Poliamide 6.6 Polyamide 6.6	Poliamide 6.6 Polyamide 6.6	Poliamide 6.6 Polyamide 6.6	Poliamide 6.6 Polyamide 6.6	Poliamide 6.6 Polyamide 6.6										
IEC	UL	CSA	IEC	UL	CSA	IEC	UL	CSA	IEC	UL	CSA	IEC	UL	CSA
1000 V	600 V	600 V	1000 V	600 V	600 V	1000 V	600 V	600 V	1000 V	600 V	600 V	1000 V	600 V	600 V
76 A	85 A	70 A	101 A	105 A	85 A	125 A	150 A	130 A	192 A	175 A	175 A	269 A	240 A	240 A
1.2 Nm	14 lb-in	14 lb-in	2.0 Nm	30 lb-in	18 lb-in	2.5 Nm	30 lb-in	25 lb-in	3.0 Nm	38 lb-in	38 lb-in	6.0 Nm	90 lb-in	90 lb-in
-	-	-	-	-										
-	PP25UN	PP35UN	-	-										
SP6/10U	-	-	-	-										
CA702	CA702	CA702	CA202	CA202										
CA802	CA802	CA802	-	-										
CA509/K12WHT	CA509/K12WHT	CA509/K16WHT	CA509/K16WHT	CA509/K16WHT										
CA751/2 (Imax 65A)	CA725/2 (Imax 90A)	CA771/2 (Imax 105A)	-	-										
CA751/3 (Imax 65A)	CA725/3 (Imax 90A)	CA771/3 (Imax 105A)	-	-										
CA751/4 (Imax 65A)	CA725/4 (Imax 90A)	CA771/4 (Imax 105A)	-	-										
CA751/10 (Imax 65A)	CA725/10 (Imax 90A)	CA771/10 (Imax 105A)	-	-										

Morsetti di terra con serraggio a vite Ground screw clamp terminal blocks

Conformità: CE, RoHS 2015/863/EU Normative: IEC60947-7-1, UL1059, CSA22.2-158 Infiammabilità: UL94V0 Temperatura di esercizio: -40°C +80°C Resistenza al calore: 100°C		Compliance: CE, RoHS 2015/863/EU Standards: IEC60947-7-1, UL1059, CSA22.2-158 Flammability: UL94V0 Working temperature: -40°C +80°C Heat resistance: 100°C					
Immagine prodotto Product image							
Articolo Item	Giallo Yellow Verde Green	CGT4N	CGT6N	CGT10N	CGT16N	CGT35U	
Schema di collegamento Connection diagram							
Dimensioni Dimensions	H x L x S	47.0 x 54.5 x 6 mm	48.2 x 54.5 x 8 mm	48.5 x 55.0 x 10 mm	48.5 x 55 x 12 mm	63.2 x 58 x 16 mm	
Conduttori connettibili per foro Connection Possibility each hole	Flessibili Flexible	1 x 0.2 ÷ 4.0 mm ² 2 x 0.2 ÷ 2.5 mm ²	1 x 0.2 ÷ 6.0 mm ² 2 x 0.2 ÷ 4.0 mm ²	1 x 0.2 ÷ 10.0 mm ² 2 x 0.2 ÷ 6.0 mm ²	1 x 0.2 ÷ 16.0 mm ² 2 x 0.2 ÷ 10.0 mm ²	1 x 0.2 ÷ 35.0 mm ² 2 x 0.2 ÷ 25.0 mm ²	
	Rigidi Solid	1 x 0.2 ÷ 6.0 mm ²		-		-	
	Con terminale With ferrule/lug	1 x 0.2 ÷ 4.0 mm ² 2 x 0.2 ÷ 2.5 mm ²	1 x 0.2 ÷ 6.0 mm ² 2 x 0.2 ÷ 4.0 mm ²	1 x 0.2 ÷ 10.0 mm ² 2 x 0.2 ÷ 6.0 mm ²	1 x 0.2 ÷ 16.0 mm ² 2 x 0.2 ÷ 10.0 mm ²	1 x 0.2 ÷ 35.0 mm ²	
Lunghezza spelatura cavo Cable stripping length		8 mm	9 mm	11 mm	12 mm	15 mm	
Materiale isolante Insulating material		Poliammide 6.6 Polyamide 6.6		Poliammide 6.6 Polyamide 6.6		Poliammide 6.6 Polyamide 6.6	
Normativa di riferimento Reference standard		IEC UL CSA	IEC UL CSA	IEC UL CSA	IEC UL CSA	IEC UL CSA	
Coppia di serraggio Tightening torque range		0.8 Nm 7 lb-in 7 lb-in	0.8 Nm 7 lb-in 7 lb-in	1,6 Nm 14 lb-in 14 lb-in	1,6 Nm 14 lb-in 14 lb-in	2,8 Nm 25 lb-in 25 lb-in	
Certificazioni Certifications							
Marcatore Marking tags		CA509/K5WHT	CA509/K6WHT	CA509/K8WHT	CA509/K10WHT	CA509/K16WHT	

Morsetti portafusibile con serraggio a vite Fuse screw clamp terminal blocks

Conformità: CE, RoHS 2015/863/EU Normative: IEC60947-7-1, UL1059, CSA22.2-158 Infiammabilità: UL94V0 Temperatura di esercizio: -40°C +80°C Resistenza al calore: 100°C				Compliance: CE, RoHS 2015/863/EU Standards: IEC60947-7-1, UL1059, CSA22.2-158 Flammability: UL94V0 Working temperature: -40°C +80°C Heat resistance: 100°C						
Immagine prodotto Product image										
Articolo Item	Grigio/Grey	CF4U		CF4UL6-60V		CF4UL110-240V				
	Blu/Blue	CF4UBU		-		-				
Schema di collegamento Connection diagram										
Dimensioni Dimensions	H x L x S	50.3 x 57.0 x 8 mm		50.3 x 57.0 x 8 mm		50.3 x 57.0 x 8 mm				
Conduttori connettibili per foro Connection Possibility each hole	Flessibili Flexible	1 x 0.2 ÷ 4.0 mm ² 2 x 0.2 ÷ 2.5 mm ²		1 x 0.2 ÷ 4.0 mm ² 2 x 0.2 ÷ 2.5 mm ²		1 x 0.2 ÷ 4.0 mm ² 2 x 0.2 ÷ 2.5 mm ²				
	Rigidi Solid	1 x 0.2 ÷ 6.0 mm ²		1 x 0.2 ÷ 6.0 mm ²		1 x 0.2 ÷ 6.0 mm ²				
	Con terminale With ferrule/lug	1 x 0.2 ÷ 4.0 mm ² 2 x 0.2 ÷ 2.5 mm ²		1 x 0.2 ÷ 4.0 mm ² 2 x 0.2 ÷ 2.5 mm ²		1 x 0.2 ÷ 4.0 mm ² 2 x 0.2 ÷ 2.5 mm ²				
Lunghezza spelatura cavo Cable stripping length		9,5 mm		9,5 mm		9,5 mm				
Materiale isolante Insulating material		Poliammide 6.6 Polyamide 6.6		Poliammide 6.6 Polyamide 6.6		Poliammide 6.6 Polyamide 6.6				
Normativa di riferimento Reference standard		IEC	UL	CSA	IEC	UL	CSA	IEC	UL	CSA
Tensione nominale Voltage Rating		800 V	600 V	600 V	800 V	600 V	600 V	800 V	600 V	600 V
Corrente nominale Current Rating		6.3 A	10 A	10 A	6.3 A	10 A	10 A	6.3 A	10 A	10 A
Coppia di serraggio Tightening torque range		0,5 Nm	7 lb-in	7 lb-in	0,5 Nm	7 lb-in	7 lb-in	0,5 Nm	7 lb-in	7 lb-in
Certificazioni Certifications										
Blocchetto terminale a incastro Interlocking end clamp		CA702		CA702		CA702				
Blocchetto terminale a vite Screw end clamp		CA802		CA802		CA802				
Marcatore su morsetto Marking tags on terminal		CA509/K8WHT		CA509/K8WHT		CA509/K8WHT				
Marcatore su portafusibile Marking tags on fuse carrier		CA509/K6WHT		CA509/K6WHT		CA509/K6WHT				

Morsetti con serraggio a vite a 2 o 3 livelli Screw clamp terminal blocks with 2 and 3 level

Conformità: CE, RoHS 2015/863/EU Normative: IEC60947-7-1, UL1059, CSA22.2-158 Infiammabilità: UL94V0 Temperatura di esercizio: -40°C +80°C Resistenza al calore: 100°C		Compliance: CE, RoHS 2015/863/EU Standards: IEC60947-7-1, UL1059, CSA22.2-158 Flammability: UL94V0 Working temperature: -40°C +80°C Heat resistance: 100°C				
Tipologia Typology		2 LIVELLI 2 LEVELS			3 LIVELLI 3 LEVELS	
Immagine prodotto Product image						
Articolo Item	Grigio/Grey	CDL4UN			CTL2.5U	
	Blu/Blue	CDL4UNBU			CTL2.5UBU	
Schema di collegamento Connection diagram						
Dimensioni Dimensions	H x L x S	59.5 x 57.5 x 6 mm			68.0 x 84.0 x 6 mm	
Conduttori connettibili per foro Connection Possibility each hole	Flessibili Flexible	1 x 0.2 ÷ 4.0 mm ² 2 x 0.2 ÷ 2.5 mm ²			1 x 0.2 ÷ 2.5 mm ² 2 x 0.2 ÷ 1.5 mm ²	
	Rigidi Solid	1 x 0.2 ÷ 6.0 mm ²			1 x 0.2 ÷ 4.0 mm ²	
	Con terminale With ferrule/lug	1 x 0.2 ÷ 4.0 mm ² 2 x 0.2 ÷ 2.5 mm ²			1 x 0.2 ÷ 2.5 mm ² 2 x 0.2 ÷ 1.5 mm ²	
Lunghezza spelatura cavo Cable stripping length		9 mm			9 mm	
Materiale isolante Insulating material		Poliammide 6.6 Polyamide 6.6			Poliammide 6.6 Polyamide 6.6	
Normativa di riferimento Reference standard		IEC	UL	CSA	IEC	UL CSA
Tensione nominale Voltage Rating		800 V	600 V	600 V	500 V	300 V 300 V
Corrente nominale Current Rating		32 A	35 A	35 A	24 A	25 A 25 A
Coppia di serraggio Tightening torque range		0.5 Nm	7 lb-in	7 lb-in	0,4 Nm	4,5 lb-in 4,5 lb-in
Certificazioni Certifications						
Terminale End plate		EPCDL4UN			EPCTL2.5U	
Separatore Separator plate		SPCDL4U			-	
Blocchetto terminale a incastro Interlocking end clamp		CA702			CA702	
Blocchetto terminale a vite Screw end clamp		CA802			CA802	
Marcatore Marking tags		CA509/K6WHT			CA509/K2WHT	
Ponte di parallelo 2 poli Shorting links 2 poles		CA722/2 (Imax 32A)			CA722/2 (Imax 24A)	
Ponte di parallelo 3 poli Shorting links 3 poles		CA722/3 (Imax 32A)			CA722/3 (Imax 24A)	
Ponte di parallelo 4 poli Shorting links 4 poles		CA722/4 (Imax 32A)			CA722/4 (Imax 24A)	
Ponte di parallelo 10 poli Shorting links 10 poles		CA722/10 (Imax 32A)			CA722/10 (Imax 24A)	

Morsetti con serraggio a vite ad alto voltaggio High voltage screw clamp terminal blocks

Conformità: CE, RoHS 2015/863/EU Normative: IEC60947-7-1, UL1059, CSA22.2-158 Infiammabilità: UL94V0 Temperatura di esercizio: -40°C +80°C Resistenza al calore: 100°C		Compliance: CE, RoHS 2015/863/EU Standards: IEC60947-7-1, UL1059, CSA22.2-158 Flammability: UL94V0 Working temperature: -40°C +80°C Heat resistance: 100°C								
Immagine prodotto Product image										
Articolo Item	Grigio/Grey	CHV4U			CHV6U			CHV10U		
	Blu/Blue	CHV4UBU			CHV6UBU			CHV10UBU		
Schema di collegamento Connection diagram										
Dimensioni Dimensions	H x L x S	63.4 x 52.0 x 6 mm			63.4 x 52.0 x 6 mm			63.4 x 52.0 x 6 mm		
Conduttori connettibili per foro Connection Possibility each hole	Flessibili Flexible	1 x 0.2 ÷ 4.0 mm ² 2 x 0.2 ÷ 2.5 mm ²			1 x 0.2 ÷ 6.0 mm ² 2 x 0.2 ÷ 4.0 mm ²			1 x 0.2 ÷ 10.0 mm ² 2 x 0.2 ÷ 6.0 mm ²		
	Rigidi Solid	1 x 0.2 ÷ 6.0 mm ²			-			-		
	Con terminale With ferrule/lug	1 x 0.2 ÷ 4.0 mm ² 2 x 0.2 ÷ 2.5 mm ²			1 x 0.2 ÷ 6.0 mm ² 2 x 0.2 ÷ 4.0 mm ²			1 x 0.2 ÷ 10.0 mm ² 2 x 0.2 ÷ 6.0 mm ²		
Lunghezza spelatura cavo Cable stripping length		12 mm			14 mm			14 mm		
Materiale isolante Insulating material		Poliammide 6.6 Polyamide 6.6			Poliammide 6.6 Polyamide 6.6			Poliammide 6.6 Polyamide 6.6		
Normativa di riferimento Reference standard		IEC	UL	CSA	IEC	UL	CSA	IEC	UL	CSA
Tensione nominale Voltage Rating		1000 V	1000 V	1000 V	1000 V	1000 V	1000 V	1000 V	1000 V	1000 V
Corrente nominale Current Rating		32 A	35 A	35 A	41 A	50 A	50 A	57 A	65 A	65 A
Coppia di serraggio Tightening torque range		0,5 Nm	7 lb-in	7 lb-in	0,8 Nm	14 lb-in	14 lb-in	1,2 Nm	14 lb-in	14 lb-in
Certificazioni Certifications										
Terminale End plate		EPUSC			EPUSC			EPUSC		
Separatore Separator plate		SP2.5/4UN			SP2.5/4UN			SP2.5/4UN		
Blocchetto terminale a incastro Interlocking end clamp		CA702			CA702			CA702		
Blocchetto terminale a vite Screw end clamp		CA802			CA802			CA802		
Marcatore Marking tags		CA509/K5WHT			CA509/K6WHT			CA509/K8WHT		
Ponte di parallelo 2 poli Shorting links 2 poles		CA623/2 (Imax 32A)			CA624/2 (Imax 41A)			CA625/2 (Imax 57A)		
Ponte di parallelo 3 poli Shorting links 3 poles		CA623/3 (Imax 32A)			CA624/3 (Imax 41A)			CA625/3 (Imax 57A)		
Ponte di parallelo 4 poli Shorting links 4 poles		CA623/4 (Imax 32A)			CA624/4 (Imax 41A)			CA625/4 (Imax 57A)		
Ponte di parallelo 10 poli Shorting links 10 poles		CA623/10 (Imax 32A)			CA624/10 (Imax 41A)			CA625/10 (Imax 57A)		







Morsetti con serraggio a molla Spring clamp terminal blocks

Conformità: CE, RoHS 2015/863/EU Normative: IEC60947-7-1, UL1059, CSA22.2-158 Infiammabilità: UL94V0 Temperatura di esercizio: -40°C +80°C Resistenza al calore: 100°C				Compliance: CE, RoHS 2015/863/EU Standards: IEC60947-7-1, UL1059, CSA22.2-158 Flammability: UL94V0 Working temperature: -40°C +80°C Heat resistance: 100°C									
Immagine prodotto Product image													
Articolo Item	Grigio/Grey	CX2.5	CX4	CX6	CX10								
	Blu/Blue	CX2.5BU	CX4BU	CX6BU	CX10BU								
Schema di collegamento Connection diagram													
Dimensioni Dimensions	H x L x S	38.0 x 50.0 x 5 mm	38.0 x 54.8 x 6 mm	43.0 x 62.1 x 8 mm	49.5 x 71.7 x 10 mm								
Conduttori connettibili per foro Connection Possibility each hole	Flessibili Flexible	1 X 0.2 ÷ 2.5 mm ²	1 X 0.2 ÷ 4.0 mm ²	1 X 0.2 ÷ 6.0 mm ²	1 X 0.2 ÷ 10.0 mm ²								
	Rigidi Solid	1 X 0.2 ÷ 4.0 mm ²	1 X 0.2 ÷ 6.0 mm ²	-	-								
	Con terminale With ferrule/lug	1 X 0.2 ÷ 2.5 mm ²	1 X 0.2 ÷ 4.0 mm ²	1 X 0.2 ÷ 6.0 mm ²	1 X 0.2 ÷ 10.0 mm ²								
Lunghezza spelatura cavo Cable stripping length		10 mm	10 mm	14 mm	18 mm								
Materiale isolante Insulating material		Poliammide 6.6 Polyamide 6.6		Poliammide 6.6 Polyamide 6.6									
Normativa di riferimento Reference standard		IEC	UL	CSA	IEC	UL	CSA	IEC	UL	CSA	IEC	UL	CSA
Tensione nominale Voltage Rating		1000 V	600 V	600 V	1000 V	600 V	600 V	1000 V	600 V	600 V	1000 V	600 V	600 V
Corrente nominale Current Rating		24 A	20 A	20 A	32 A	30 A	30 A	41 A	50 A	50 A	57 A	65 A	65 A
Certificazioni Certifications													
Terminale End plate		EPCX2.5		EPCX4		EPCX6		EPCX6		EPCX10		EPCX10	
Diaframma Partition plate		PPCX4		PPCX4		PPCX10		PPCX10		PPCX10		PPCX10	
Blocchetto terminale a incastro Interlocking end clamp		CA702		CA702		CA702		CA702		CA702		CA702	
Blocchetto terminale a vite Screw end clamp		CA802		CA802		CA802		CA802		CA802		CA802	
Marcatore Marking tags		CA509/K5WHT		CA509/K6WHT		CA509/K8WHT		CA509/K8WHT		CA509/K10WHT		CA509/K10WHT	
Ponte di parallelo 2 poli Shorting links 2 poles		JX2.5/2 (Imax 24A)		JX4/2 (Imax 32A)		JX6/2 (Imax 32A)		JX6/2 (Imax 32A)		JX10/2 (Imax 57A)		JX10/2 (Imax 57A)	
Ponte di parallelo 3 poli Shorting links 3 poles		JX2.5/3 (Imax 24A)		JX4/3 (Imax 32A)		JX6/3 (Imax 32A)		JX6/3 (Imax 32A)		-		-	
Ponte di parallelo 4 poli Shorting links 4 poles		JX2.5/4 (Imax 24A)		JX4/4 (Imax 32A)		JX6/4 (Imax 32A)		JX6/4 (Imax 32A)		-		-	
Ponte di parallelo 8 poli Shorting links 8 poles		JX2.5/8 (Imax 24A)		JX4/8 (Imax 32A)		-		-		-		-	
Ponte di parallelo 10 poli Shorting links 10 poles		JX2.5/10 (Imax 24A)		JX4/10 (Imax 32A)		JX6/10 (Imax 32A)		JX6/10 (Imax 32A)		-		-	

Morsetti di terra con serraggio a molla Ground/Earth spring clamp terminal blocks

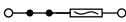
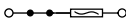
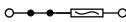
Conformità: CE, RoHS 2015/863/EU Normative: IEC60947-7-1, UL1059, CSA22.2-158 Infiammabilità: UL94V0 Temperatura di esercizio: -40°C +80°C Resistenza al calore: 100°C				Compliance: CE, RoHS 2015/863/EU Standards: IEC60947-7-1, UL1059, CSA22.2-158 Flammability: UL94V0 Working temperature: -40°C +80°C Heat resistance: 100°C									
Immagine prodotto Product image													
Articolo Item	Giallo Yellow Verde Green	CXG2.5	CXG4	CXG6	CXG10								
Schema di collegamento Connection diagram													
Dimensioni Dimensions	H x L x S	38.0 x 50.0 x 5 mm	38.0 x 54.8 x 6 mm	43.0 x 62.1 x 8 mm	49.5 x 71.7 x 10 mm								
Conduttori connettabili per foro Connection Possibility each hole	Flessibili Flexible	1 X 0.2 ÷ 2.5 mm ²	1 X 0.2 ÷ 4.0 mm ²	1 X 0.2 ÷ 6.0 mm ²	1 X 0.2 ÷ 10.0 mm ²								
	Rigidi Solid	1 X 0.2 ÷ 4.0 mm ²	1 X 0.2 ÷ 6.0 mm ²	-	-								
	Con terminale With ferrule/lug	1 X 0.2 ÷ 2.5 mm ²	1 X 0.2 ÷ 4.0 mm ²	1 X 0.2 ÷ 6.0 mm ²	1 X 0.2 ÷ 10.0 mm ²								
Lunghezza spelatura cavo Cable stripping length		10 mm	10 mm	14 mm	18 mm								
Materiale isolante Insulating material		Poliammide 6.6 Polyamide 6.6		Poliammide 6.6 Polyamide 6.6									
Normativa di riferimento Reference standard		IEC	UL	CSA	IEC	UL	CSA	IEC	UL	CSA	IEC	UL	CSA
Tensione nominale Voltage Rating		1000 V	600 V	600 V	1000 V	600 V	600 V	1000 V	600 V	600 V	1000 V	600 V	600 V
Corrente nominale Current Rating		24 A	20 A	20 A	24 A	20 A	20 A	32 A	30 A	30 A	32 A	30 A	30 A
Certificazioni Certifications													
Terminale End plate		EPCX2.5		EPCX4		EPCX6		EPCX10					
Diaframma Partition plate		PPCX4		PPCX4		PPCX10		PPCX10					
Blocchetto terminale a incastro Interlocking end clamp		CA702		CA702		CA702		CA702					
Blocchetto terminale a vite Screw end clamp		CA802		CA802		CA802		CA802					
Marcatore Marking tags		CA509/K5WHT		CA509/K6WHT		CA509/K8WHT		CA509/K10WHT					
Ponte di parallelo 2 poli Shorting links 2 poles		JX2.5/2 (I _{max} 24A)		JX4/2 (I _{max} 32A)		JX6/2 (I _{max} 32A)		JX10/2 (I _{max} 57A)					
Ponte di parallelo 3 poli Shorting links 3 poles		JX2.5/3 (I _{max} 24A)		JX4/3 (I _{max} 32A)		JX6/3 (I _{max} 32A)		-					
Ponte di parallelo 4 poli Shorting links 4 poles		JX2.5/4 (I _{max} 24A)		JX4/4 (I _{max} 32A)		JX6/4 (I _{max} 32A)		-					
Ponte di parallelo 8 poli Shorting links 8 poles		JX2.5/8 (I _{max} 24A)		JX4/8 (I _{max} 32A)		-		-					
Ponte di parallelo 10 poli Shorting links 10 poles		JX2.5/10 (I _{max} 24A)		JX4/10 (I _{max} 32A)		JX6/10 (I _{max} 32A)		-					

Morsetti portafusibile con serraggio a molla Fuse spring clamp terminal blocks

Conformità: CE, RoHS 2015/863/EU Normative: IEC60947-7-1, UL1059, CSA22.2-158 Infiammabilità: UL94V0 Temperatura di esercizio: -40°C +80°C Resistenza al calore: 100°C		Compliance: CE, RoHS 2015/863/EU Standards: IEC60947-7-1, UL1059, CSA22.2-158 Flammability: UL94V0 Working temperature: -40°C +80°C Heat resistance: 100°C								
Immagine prodotto Product image										
Articolo Item	Grigio/Grey	CXF4			CXF4L6-60V			CXF4L110-240V		
Schema di collegamento Connection diagram										
Dimensioni Dimensions	H x L x S	61.5 x 65.4 x 6 mm			61.5 x 65.4 x 6 mm			61.5 x 65.4 x 6 mm		
Conduttori connettibili per foro Connection Possibility each hole	Flessibili Flexible	1 X 0.2 ÷ 4.0 mm ²			1 X 0.2 ÷ 4.0 mm ²			1 X 0.2 ÷ 4.0 mm ²		
	Rigidi Solid	1 X 0.2 ÷ 6.0 mm ²			1 X 0.2 ÷ 6.0 mm ²			1 X 0.2 ÷ 6.0 mm ²		
	Con terminale With ferrule/lug	1 X 0.2 ÷ 4.0 mm ²			1 X 0.2 ÷ 4.0 mm ²			1 X 0.2 ÷ 4.0 mm ²		
Lunghezza spelatura cavo Cable stripping length		10 mm			10 mm			10 mm		
Materiale isolante Insulating material		Poliammide 6.6 Polyamide 6.6			Poliammide 6.6 Polyamide 6.6			Poliammide 6.6 Polyamide 6.6		
Normativa di riferimento Reference standard		IEC	UL	CSA	IEC	UL	CSA	IEC	UL	CSA
Tensione nominale Voltage Rating		1000 V	600 V	600 V	1000 V	600 V	600 V	1000 V	600 V	600 V
Corrente nominale Current Rating		10 A	10 A	10 A	10 A	10 A	10 A	10 A	10 A	10 A
Certificazioni Certifications										
Blocchetto terminale a incastro Interlocking end clamp		CA702			CA702			CA702		
Blocchetto terminale a vite Screw end clamp		CA802			CA802			CA802		
Marcatore Marking tags		CA509/K6WHT			CA509/K6WHT			CA509/K6WHT		
Ponte di parallelo 2 poli Shorting links 2 poles		JX4/2 (Imax 32A)			JX4/2 (Imax 32A)			JX4/2 (Imax 32A)		
Ponte di parallelo 3 poli Shorting links 3 poles		JX4/3 (Imax 32A)			JX4/3 (Imax 32A)			JX4/3 (Imax 32A)		
Ponte di parallelo 4 poli Shorting links 4 poles		JX4/4 (Imax 32A)			JX4/4 (Imax 32A)			JX4/4 (Imax 32A)		
Ponte di parallelo 8 poli Shorting links 8 poles		JX4/8 (Imax 32A)			JX4/8 (Imax 32A)			JX4/8 (Imax 32A)		
Ponte di parallelo 10 poli Shorting links 10 poles		JX4/10 (Imax 32A)			JX4/10 (Imax 32A)			JX4/10 (Imax 32A)		

Morsetti 2 e 3 livelli con serraggio a molla 2 and 3 level spring clamp terminal blocks



Conformità: CE, RoHS 2015/863/EU Normative: IEC60947-7-1, UL1059, CSA22.2-158 Infiammabilità: UL94V0 Temperatura di esercizio: -40°C +80°C Resistenza al calore: 100°C		Compliance: CE, RoHS 2015/863/EU Standards: IEC60947-7-1, UL1059, CSA22.2-158 Flammability: UL94V0 Working temperature: -40°C +80°C Heat resistance: 100°C					
Tipologia Typology		2 LIVELLI 2 LEVELS		3 LIVELLI 3 LEVELS			
Immagine prodotto Product image							
Articolo Item	Grigio/Grey	CXDL2.5		CP3L2.5			
	Blu/Blue	CXDL2.5BU		-			
Schema di collegamento Connection diagram							
Dimensioni Dimensions	H x L x S	49.5 x 72.7 x 5 mm		83.1 x 98.7 x 5 mm			
Conduttori connettibili per foro Connection Possibility each hole	Flessibili Flexible	1 X 0.2 ÷ 2.5 mm ²		1 X 0.2 ÷ 2.5 mm ²			
	Rigidi Solid	1 X 0.2 ÷ 4.0 mm ²		1 X 0.2 ÷ 4.0 mm ²			
	Con terminale With ferrule/lug	1 X 0.2 ÷ 2.5 mm ²		1 X 0.2 ÷ 2.5 mm ²			
Lunghezza spelatura cavo Cable stripping length		10 mm		10 mm			
Materiale isolante Insulating material		Poliamide 6.6 Polyamide 6.6		Poliamide 6.6 Polyamide 6.6			
Normativa di riferimento Reference standard		IEC	UL	CSA	IEC	UL	CSA
Tensione nominale Voltage Rating		1000 V	600 V	600 V	500 V	300 V	-
Corrente nominale Current Rating		24 A	20 A	20 A	24 A	20 A	-
Certificazioni Certifications							
Terminale End plate		EPCXDL2.5		EPCP3L2.5			
Blocchetto terminale a incastro Interlocking end clamp		CA702		CA702			
Blocchetto terminale a vite Screw end clamp		CA802		CA802			
Marcatore Marking tags		CA509/K5WHT		CA509/K6WHT			
Ponte di parallelo 2 poli Shorting links 2 poles		JX2.5/2 (Imax 24A)		CA801/A2 (Imax 24A)			
Ponte di parallelo 3 poli Shorting links 3 poles		JX2.5/3 (Imax 24A)		CA801/A3 (Imax 24A)			
Ponte di parallelo 4 poli Shorting links 4 poles		JX2.5/4 (Imax 24A)		CA801/A4 (Imax 24A)			
Ponte di parallelo 8 poli Shorting links 8 poles		JX2.5/8 (Imax 24A)		-			
Ponte di parallelo 10 poli Shorting links 10 poles		JX2.5/10 (Imax 24A)		CA801/A10 (Imax 24A)			

Pressacavi IP68 con controdamo Cable glands IP68 with locknut

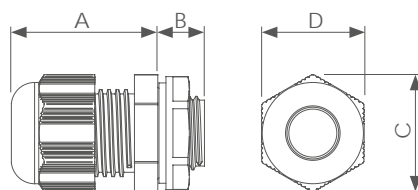
Grado di protezione: IP68 5 bar (30 min) IP66
Materiale pressacavo: Poliammide 6
Materiale guarnizione: Cloroprene
Temperatura d'esercizio: -20°C +100°C, intermittente -30 +150°C
Certificazioni: VDE, CSA, UL
Conformità: CE, RoHS 2015/863/EU
Protection degree: IP68 5 bar (30 min) IP66
Cable glands material: Polyamide 6
Sealing material: Chloroprene
Working temperature: -20°C +100°C, intermittent -30 +150°C
Approvals: VDE, CSA, UL
Compliance: CE, RoHS 2015/863/EU



SISTEMA DI SERRAGGIO ANTIVIBRAZIONE ANTIVIBRATION CLAMPING SYSTEM

Dimensione filettatura Thread size	Lunghezza filettatura Thread length	Campo di serraggio Clamping range			Dimensioni Dimensions				
					A mm	B mm	C mm	D mm	
								Corpo Body	Testa Head
M12	8	3-6,5	-	124M1201B	25,3	8	17	15	15
M16	8	4-8	-	124M1601B	27,4	8	21,7	19	19
M20	10	6-12	-	124M2001B	27	10	27	24	24
M25	8	11-17	-	124M2501B	37,7	8	37,7	29	29
M32	10	15-21	-	124M3201B	42,3	10	41	36	36
M40	10	19-28	-	124M4001B	47,4	10	52,4	46	46
PG7	8	3 - 6,5	124P0701B	124P0701BE	25,3	8	17	15	15
PG9	8	4 - 8	124P0901B	124P0901BE	27,4	8	21,7	19	19
PG11	8	5 - 10	124P1101B	124P1101BE	32,2	8	25	22	22
PG13,5	9	6 - 12	124P1301B	124P1301BE	32,4	10	27	24	24
PG16	10	10 - 14	124P1601B	124P1601BE	31,9	10	30,9	27	27
PG21	11	13 - 18	124P2101B	124P2101BE	38,4	11	37,2	33	33
PG29	11	18 - 25	124P2901B	124P2901BE	43,3	11	47,1	42	42



I pressacavi 124P.. 01B sono forniti con un tappo di protezione colorato.

The cable glands 124P .. 01B are supplied with coloured protection cap.

Tutti i pressacavi con codice finale B e BE (passo PG e Metrico) sono forniti con controdamo e sono imballati in sacchetti con foro Euroslot.

The cable glands with final code B or BE (PG and Metric thread) are supplied with locknut and packaging with bag with Euroslot hole.



Pressacavi IP68 Cable glands IP68

<p>Grado di protezione: IP68 5 bar (30 min) IP66 Materiale pressacavo: Poliammide 6 Materiale guarnizione: Cloroprene Temperatura d'esercizio: -20°C +100°C, intermittente -30 +150°C Certificazioni: VDE, CSA, UL Conformità: CE, RoHS 2015/863/EU 124M...EX03: per ambienti a rischio di esplosione EEX e II livello "e" Protection degree: IP68 5 bar (30 min) IP66 Cable glands material: Polyamide 6 Sealing material: Chloroprene Working temperature: -20°C +100°C, intermittent -30 +150°C Approvals: VDE, CSA, UL Compliance: CE, RoHS 2015/863/EU 124M...EX03: for explosive areas EEX e II safety level "e"</p>	
---	--



SISTEMA DI SERRAGGIO ANTIVIBRAZIONE ANTIVIBRATION CLAMPING SYSTEM

Dimensione filettatura Thread size	Lunghezza filettatura Thread length	Campo di serraggio Clamping range				Dimensioni Dimensions				
						A mm	B mm	C mm	D mm	
									Corpo Body	Testa Head
mm	Ø mm	Grigio Grey RAL7035	Nero Black RAL9005	Nero Black RAL9005						
M12	8	3-6,5	350M1201	350M1203	124M12EX03	25,3	8	17	15	15
M16	8	4-8	350M1601	350M1603	124M16EX03	27,4	8	21,7	19	19
M20	10	6-12	350M2001	350M2003	124M20EX03	27	10	27	24	24
M25	8	11-17	350M2501	350M2503	124M25EX03	37,7	8	37,7	29	29
M32	10	15-21	350M3201	350M3203	124M32EX03	42,3	10	41	36	36
M40	10	19-28	350M4001	350M4003	124M40EX03	47,4	10	52,4	46	46
M50	18	30-38	350M5001	350M5003	-	54,8	18	67,8	60	60
M63	18	34-44	350M6301	350M6303	-	54,9	18	72,4	65	65
NPT3/8"	15	5-10	124NPT3801	-	-	32,2	15	25	22	22
NPT1/2"	15	6-12	124NPT1201	-	-	32,4	15	27	24	24
NPT3/4"	15	13-18	124NPT3401	-	-	38,4	15	37,2	33	33
NPT1"	18	18-25	124NPT101	-	-	43,3	18	47,1	42	42
PG7	8	3-6,5	350P0701	-	-	25,3	8	17	15	15
PG9	8	4-8	350P0901	-	-	27,4	8	21,7	19	19
PG11	8	5-10	350P1101	-	-	32,2	8	25	22	22
PG13,5	9	6-12	350P1301	-	-	32,4	10	27	24	24
PG16	10	10-14	350P1601	-	-	31,9	10	30,9	27	27
PG21	11	13-18	350P2101	-	-	38,4	11	37,2	33	33
PG29	11	18-25	350P2901	-	-	43,3	11	47,1	42	42
PG36	13	22-32	350P3601	-	-	52,4	13	59,6	53	53
PG42	13	30-38	350P4201	-	-	54,8	13	67,8	60	60
PG48	14	34-44	350P4801	-	-	54,9	14	72,4	65	65

Pressacavi con sistema di ventilazione anticondensa Cable glands with anti-condensation ventilation system

<p>Grado di protezione: IP67 Materiale pressacavo: Poliammide 6.6 Materiale guarnizione: Cloroprene Temperatura d'esercizio: -20°C +100°C Certificazioni: VDE, CSA, UL, DNV-GL Conformità: CE, RoHS 2015/863/EU Protection degree: IP67 Cable glands material: Polyamide 6 Sealing material: Chloroprene Working temperature: -20°C +100°C Approvals: VDE, CSA, UL, DNV-GL Compliance: CE, RoHS 2015/863/EU</p>										
Dimensione filettatura Thread size	Lunghezza filettatura Thread length	Campo di serraggio Clamping range	Flusso d'aria medio Average air flow ΔP = 70 mbar/1 psi	Passaggio d'acqua Water intrusion	<p>Grigio Grey RAL7035</p>	Dimensioni Dimensions				
	mm	mm	l/h	bar		A mm	B mm	C mm	D mm	
M12	8	4-7	25	0,1	350MV1201	28,3	8	21,7	19	19
M16	10	4-7	25	0,1	350MV1601	28,3	10	21,7	19	19
M20	10	6-11	40	0,1	350MV2001	33,3	10	27,0	24	24

Tappo di scarico anticondensa Anti-condensation drain plug

<p>Grado di protezione: IP56/IP66 (Categoria 2) Materiale pressacavo: Poliammide 66 (RAL7035) Temperatura d'esercizio: -20°C +100°C Certificazioni: VDE, CSA, UL, DNV-GL Conformità: CE, RoHS 2015/863/EU Protection degree: IP56/IP66 (Category 2) Cable glands material: Polyamide 66 (RAL7035) Working temperature: -20°C +100°C Approvals: VDE, CSA, UL, DNV-GL Compliance: CE, RoHS 2015/863/EU</p>										
Dimensione filettatura Thread size	Campo di serraggio Clamping range	<p>Tappo Plug</p>	<p>Controdado Lock nut</p>	Dimensioni Dimensions				Dimensioni Dimensions		
	mm			A mm	B mm	C mm	D mm	E mm	F mm	G mm
M12	4-7	514MS12	3420MS12	17	12	19	18	7	19,2	18

Il tappo 514MS12 può essere applicato sotto scatole di derivazione o quadri elettrici, la funzione è semplicissima, espelle per gravità la condensa che si può formare sul fondo degli involucri che subiscono sbalzi di temperatura tra l'interno e l'esterno.

The cap 514MS12 can be applied under derivation boxes or electrical panels, the function is very simple, by gravity it expels the condensate water that can form on the bottom of the casings that undergo temperature changes between the inside and the outside.

In che modo si forma la condensa all'interno di un involucro? How does condensation form inside an enclosure?

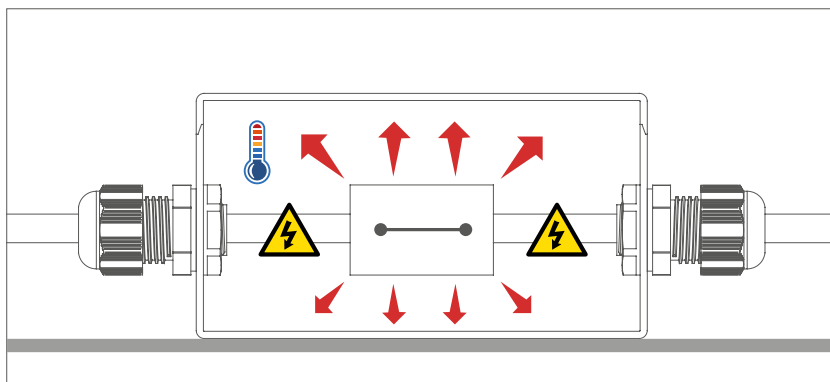

Durante il funzionamento le connessioni elettriche contenute all'interno dell'involucro emettono calore riscaldando a loro volta tutta la superficie che si mantiene calda per le ore successive.

During operation, the electrical connections contained within the casing emit heat, in turn heating the entire surface which remains hot for the following hours.

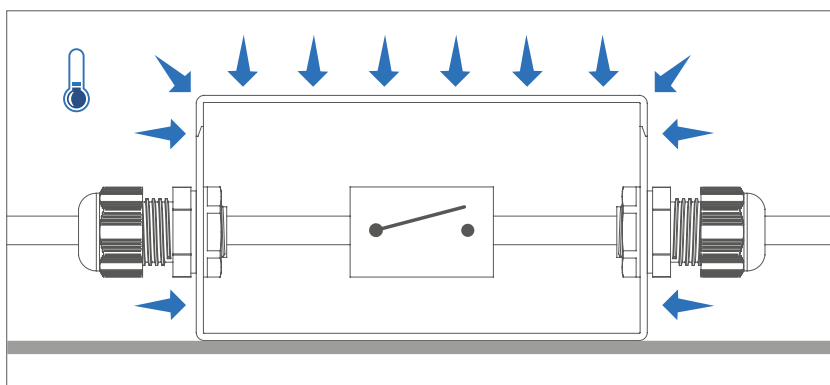

Dopo lo spegnimento o durante la notte le differenze di temperatura tra l'interno e l'esterno creano una bassa pressione all'interno dell'involucro che si trasforma in condensa.

After switching off or during the night, the temperature differences between the inside and the outside create a low pressure inside the casing which transforms into condensation.

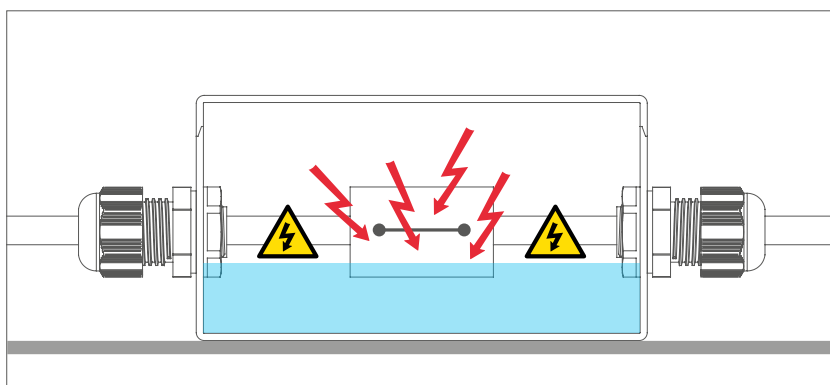

La condensa contenuta all'interno dell'involucro aggredisce le connessioni elettriche che a loro volta provocano un corto circuito creando danni irreparabili all'impianto collegato.

The condensation contained inside the casing attacks the electrical connections which in turn cause the short circuit, creating irreparable damage to the connected system.

Come funziona il pressacavo ventilato? How does the fan cable gland work?

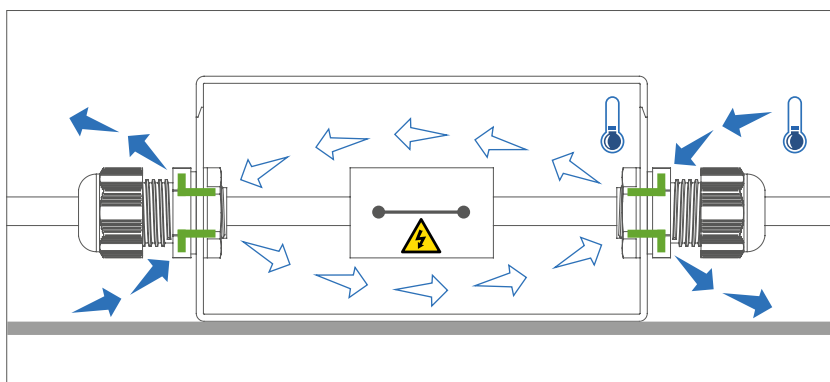





Questi pressacavi contengono al loro interno una membrana speciale in PTFE la quale consente un'elevata portata d'aria adattando perfettamente la pressione interna dell'involucro a quella esterna.

These cable glands contain a special PTFE membrane inside which allows a high air flow rate by perfectly adapting the internal pressure of the casing to the external one.

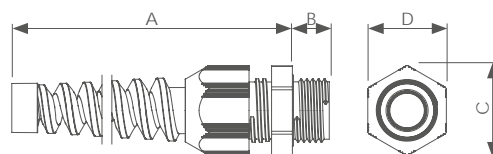
Pressacavi con proteggicavo IP68 Cable glands with cable protection IP68

Grado di protezione: IP68 5 bar (30 min) IP66
Materiale pressacavo: Poliammide 6
Materiale guarnizione: Cloroprene
Temperatura d'esercizio: -20°C +100°C, intermittente -30 +150°C
Certificazioni: VDE, CSA, UL
Conformità: CE, RoHS 2015/863/EU
Protection degree: IP68 5 bar (30 min) IP66
Cable glands material: Polyamide 6
Sealing material: Chloroprene
Working temperature: -20°C +100°C, intermittent -30 +150°C
Approvals: VDE, CSA, UL
Compliance: CE, RoHS 2015/863/EU



Dimensione filettatura Thread size	Lunghezza filettatura Thread length	Campo di serraggio Clamping range			Dimensioni Dimensions				
					A mm	B mm	C mm	D mm	
	mm	Ø mm	Grigio Grey RAL7035	Nero Black RAL9005				Corpo Body	Testa Head
M16	10	5-10	124SM1601	124SM1603	83,2	10	25,1	22	22
M20	10	10-14	124SM2001	124SM2003	106,4	10	30,5	27	27
M25	10	13-18	124SM2501	124SM2503	118,9	10	37,8	33	33

PG7	8	3-6,5	-	124SP0703	58	8	16,6	15	15
PG9	8	4-8	-	124SP0903	68,4	8	21,5	19	19
PG11	8	5-10	-	124SP1103	83,2	8	25,1	22	22
PG13,5	10	6-12	-	124SP1303	96,5	10	27,6	24	24
PG16	10	10-14	-	124SP1603	106,4	10	30,5	27	27

Pressacavi IP68 in OTTONE Cable glands IP68 of BRASS

Grado di protezione: IP68 5 bar (30 min) IP66
Materiale pressacavo: Ottone nichelato
Materiale guarnizione: Cloroprene
Temperatura d'esercizio: -20°C +100°C, intermittente -40 +150°C
Certificazioni: VDE, CSA, UL
Conformità: CE, RoHS 2015/863/EU
Protection degree: IP68 5 bar (30 min) IP66
Cable glands material: nickel plated Brass
Sealing material: Chloroprene
Working temperature: -20°C +100°C, intermittent -40 +150°C
Approvals: VDE, CSA, UL
Compliance: CE, RoHS 2015/863/EU

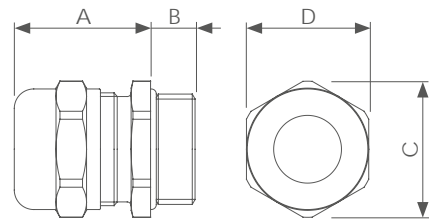

Dimensione filettatura Thread size	Lunghezza filettatura Thread length	Campo di serraggio Clamping range		Dimensioni Dimensions				
				A mm	B mm	C mm	D mm	
							Corpo Body	Testa Head
M12	6	3-6,5	2532M12A	24	6	15,5	14	14
M16	7	4-8	2532M16A	25,5	7	20	17	18
M20	8	6-12	2532M20A	26,5	8	24,5	22	22
M25	8	10-14	2532M25A	30	8	30	24	27
M32	9	13-18	2532M32A	35	9	37,5	30	34
M40	9	18-25	2532M40A	40,5	9	48,5	40	43
M50	9	22-32	2532M50A	50	9	61	50	55
M63	14	34-44	2532M63A	55	14	75	64	68

Pressacavi IP68 con inserimento rapido SLIP-IN Cable glands IP68 with SLIP-IN quick insertion

Grado di protezione: IP68 5 bar (30 min) IP66
Materiale pressacavo: Poliammide 6
Materiale guarnizione: Cloroprene
Temperatura d'esercizio: -20°C +100°C, intermittente -30 +150°C
Spessore di fissaggio: minimo 0,5 mm e massimo 4 mm
Certificazioni: VDE, CSA, UL
Conformità: CE, RoHS 2015/863/EU
Protection degree: IP68 5 bar (30 min) IP66
Cable glands material: Polyamide 6
Sealing material: Chloroprene
Working temperature: -20°C +100°C, intermittent -30 +150°C
Fixing thickness: minimum 0.5 mm and maximum 4 mm
Approvals: VDE, CSA, UL
Compliance: CE, RoHS 2015/863/EU

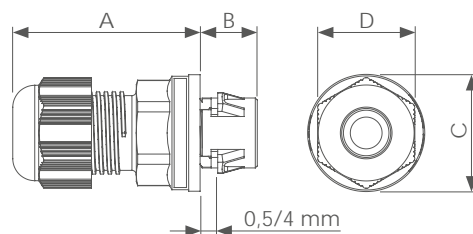

Dimensione foro Enclosure hole	Campo di serraggio Clamping range	Foro di fissaggio Insertion hole			Dimensioni Dimensions				
					A mm	B mm	C mm	D mm	
mm	∅ mm	∅ mm	Grigio Grey RAL7035	Nero Black RAL9005				Corpo Body	Testa Head
16,2 - 16,4	5-10	16	124M1601C	124M1603C	44,5	9	26,5	22	22
20,2 - 20,4	6-12	20	124M2001C	124M2003C	43,5	9	30,3	24	24
25,2 - 25,4	11-17	25	124M2501C	124M2503C	45,5	9	36,3	29	29
32,2 - 32,4	15-21	32	124M3201C	124M3203C	51,5	9	43,2	36	36
40,2 - 40,4	19-28	40	124M4001C	124M4003C	58	13,2	55,2	46	46



Inserire il pressacavo nel foro. Il pressacavo è fornito di guarnizione in gomma per garantire l'IP68.

Insert the cable gland in the hole. The cable gland is supplied with rubber seal to guarantee the IP68.



Premere a fondo fino allo scatto. Questo sistema innovativo riduce notevolmente i tempi d'installazione.

Press the cable gland until it clicks. This innovative system significantly reduces installation times.



Premere e girare contemporaneamente la base del pressacavo fino al completo bloccaggio.

Simultaneously press and turn the base of the cable gland until completely locked.

Pressacavi IP68 con inserimento rapido SLIP-IN in OTTONE Cable glands IP68 with SLIP-IN quick insertion of BRASS

<p>Grado di protezione: IP68 5 bar (30 min) IP66 Materiale pressacavo: Ottone Nichelato Materiale guarnizione: Cloroprene Temperatura d'esercizio: -20°C +100°C, intermittente -30 +150°C Spessore di fissaggio: min 0,5 mm, max 4 mm Certificazioni: VDE, CSA, UL Conformità: CE, RoHS 2015/863/EU Protection degree: IP68 5 bar (30 min) IP66 Cable glands material: Nickel-plated brass Sealing material: Chloroprene Working temperature: -20°C +100°C, intermittent -30 +150°C Fixing thickness: min 0.5 mm, max 4 mm Approvals: VDE, CSA, UL Compliance: CE, RoHS 2015/863/EU</p>								
Dimensione foro Enclosure hole	Campo di serraggio Clamping range	Foro di fissaggio Insertion hole		Dimensioni Dimensions				
				A mm	B mm	C mm	D mm	
mm	Ø mm	Ø mm				Corpo Body	Testa Head	
16,2 - 16,4	5-10	16	2532M16C	47	9	28,3	20	20
20,2 - 20,4	6-12	20	2532M20C	46	9	32,3	22	22
25,2 - 25,4	11-17	25	2532M25C	48	9	38,5	27	27
32,2 - 32,4	15-21	32	2532M32C	56,5	9	45,5	34	34
40,2 - 40,4	19-28	40	2532M40C	64	13,2	59	43	43

Attrezzo per disassemblare i pressacavi SLIP-IN Tool to disassemble SLIP-IN glands

Dimensione Size	Articolo Item		
M16	124M16DT		
M20	124M20DT		
M25	124M25DT		
M32	124M32DT		
M40	124M40DT		

Controdadi Locknuts

<p>Materiale: Poliammide 6 (Plastica) Ottone nichelato</p> <p>Temperatura d'esercizio: -20°C +100°C, intermittente -30 +150°C</p> <p>Conformità: CE, RoHS 2015/863/EU</p> <p>Material: Polyamide 6 (Plastic) Nickel plated Brass</p> <p>Working temperature: -20°C +100°C, intermittent -30 +150°C</p> <p>Compliance: CE, RoHS 2015/863/EU</p>	
--	--

Dimensione filettatura Thread size	Controdado Lock nut			Dimensioni Dimension			
				Plastica Plastic	Ottone Brass	Plastica Plastic	Ottone Brass
	Plastica grigia Grey plastic RAL7035	Plastica Nera Black plastic RAL9005	Ottone Brass	A mm	A mm	E mm	E mm
M12	3420M12	3420M1203	420M12	5	2,8	18	15
M16	3420M16	3420M1603	420M16	5	3	22	19
M20	3420M20	3420M2003	420M20	6	3,5	26	24
M25	3420M25	3420M2503	420M25	6	4	32	30
M32	3420M32	3420M3203	420M32	7	5	41	36
M40	3420M40	3420M4003	420M40	7	5	50	46
M50	3420M50	3420M5003	420M50	8	5	60	60
M63	3420M63	3420M6303	420M63	8	6	75	70

NPT3/8"	3420NPT3801			7		22	
NPT1/2"	3420NPT1201			7		27	
NPT3/4"	3420NPT3401			7		33	
NPT1"	3420NPT101			7		41	

PG7	3420P07			5		19	
PG9	3420P09			5		22	
PG11	3420P11			5		24	
PG13,5	3420P13			6		27	
PG16	3420P16			6		30	
PG21	3420P21			7		36	
PG29	3420P29			7		46	
PG36	3420P36			8		60	
PG42	3420P42			8		65	
PG48	3420P48			8		70	

Tappi filettati e guarnizioni Screw plugs and sealing rings

<p>Materiale: Poliammide 6 Temperatura d'esercizio: -20°C +100°C intermittente -30 +150°C Conformità: CE, RoHS 2015/863/EU Material: Polyamide 6 Working temperature: -20°C +100°C intermittent -30 +150°C Compliance: CE, RoHS 2015/863/EU</p>	<p>Materiale: gomma Dutral Temperatura d'esercizio: -40°C +100°C Conformità: CE, RoHS 2015/863/EU Material: Dutral rubber Working temperature: -40°C +100°C Compliance: CE, RoHS 2015/863/EU</p>
--	---

Dimensione filettatura Thread size	Tappo filettato Screw plug				Guarnizione Sealing ring			
	Plastica grigia Grey plastic RAL7035	B mm	C mm	D mm	Gomma nera Black rubber	B mm	C mm	D mm
M12	514M12	6	9	18	986DM12	1,5	18	11
M16	514M16	6	9,4	22	986DM16	1,5	21	15
M20	514M20	6	9	26	986DM20	1,5	27	19
M25	514M25	6	10	32	986DM25	1,5	34	24
M32	514M32	8	12	41	986DM32	1,5	40	32
M40	514M40	8	12,5	50	986DM40	1,5	51	39
M50	514M50	10	13,7	60	986DM50	1,5	60	48
M63	514M63	12	16,5	73	986DM63	1,5	72	62

PG7	514P07	6	9	15	986DP07	1,5	17	12
PG9	514P09	6	9	19,5	986DP09	1,5	20	15
PG11	514P11	6	9	22	986DP11	1,5	23	18
PG13,5	514P13	6	9	24,7	986DP13	1,5	25	20
PG16	514P16	6	9,4	27	986DP16	1,5	28	22
PG21	514P21	8	12	33	986DP21	1,5	38	28
PG29	514P29	8	11,2	44	986DP29	1,5	45	37
PG36	514P36	10	13,7	55	986DP36	1,5	56	47
PG42	514P42	10	16	62	986DP42	1,5	62	54
PG48	514P48	12	18,5	69	986DP48	1,5	69	59

Fascette per cablaggio Cable ties

Materiale: Poliammide 6.6 (Senza Alogeni)
Temperatura d'esercizio: -40°C +85°C
Temperatura di installazione: -10°C +60°C
Resistenza alla fiamma: UL94 V2
Conformità: CE, RoHS 2015/863/EU
Material: Polyamide 6.6 (Halogen Free)
Working temperature: -40°C +85°C
Installation temperature: -10°C +60°C
Flammability resistance: UL94 V2
Compliance: CE, RoHS 2015/863/EU

Dimensioni Dimensions		
	Neutro Neutral	Nero Black
mm		
100 x 2,5	F10025	F10025N
135 x 2,5	F14025	F14025N
160 x 2,5	F16025	F16025N
200 x 2,5	F20025	F20025N
140 x 3,6	F14036	F14036N
200 x 3,6	F20036	F20036N
290 x 3,6	F29036	F29036N
370 x 3,6	F36036	F36036N
120 x 4,5	F12048	F12048N
160 x 4,8	F16048	F16048N
200 x 4,8	F20048	F20048N
250 x 4,8	F25048	F25048N
290 x 4,8	F29048	F29048N
360 x 4,8	F36048	F36048N
390 x 4,8	F39048	F39048N
430 x 4,8	F43048	F43048N
180 x 7,8	F20076	F20076N
240 x 7,8	F25076	F25076N
300 x 7,8	F30076	F30076N
365 x 7,8	F36076	F36076N
450 x 7,5	F45076	F45076N
540 x 7,8	F54076	F54076N
750 x 7,5	F75076	F75076N
780 x 9,0	F78090	F78090N
500 x 12,5	F500125	F500125N
720 x 12,5	F720125	F720125N
850 x 12,5	F850125	F850125N
1000 x 12,5	F1000125	F1000125N

Targhetta per siglatura Plate for labeling





Materiale: Poliammide 6.6 (Senza Alogeni)
Temperatura d'esercizio: -40°C +85°C
Temperatura di installazione: -10°C +60°C
Resistenza alla fiamma: UL94 V2
Conformità: CE, RoHS 2015/863/EU
Material: Polyamide 6.6 (Halogen Free)
Working temperature: -40°C +85°C
Installation temperature: -10°C +60°C
Flammability resistance: UL94 V2
Compliance: CE, RoHS 2015/863/EU

Per fascette For Cable Ties	
mm	Neutro Neutral
100 x 2,5	FTS1550 50x15 mm
135 x 2,5	
160 x 2,5	
200 x 2,5	

Fascette per siglatura Cable ties for marking

Materiale: Poliammide 6.6 (Senza Alogeni)
Temperatura d'esercizio: -40°C +85°C
Temperatura di installazione: -10°C +60°C
Resistenza alla fiamma: UL94 V2
Conformità: CE, RoHS 2015/863/EU
Material: Polyamide 6.6 (Halogen Free)
Working temperature: -40°C +85°C
Installation temperature: -10°C +60°C
Flammability resistance: UL94 V2
Compliance: CE, RoHS 2015/863/EU

USO INTERNO INTERNAL USE		
Targhetta Plate	20 x 9 mm	25 x 8 mm
Dimensioni Dimensions		
mm	Neutro Neutral	Neutro Neutral
100 x 2,5	FTS10025	FT10025
200 x 2,5	-	FT20025
200 x 3,6	FTS20025	-

Supporti di fissaggio per fascette Fixing supports for cable ties

Materiale: Poliammide6.6 (Senza Alogeni) Temperatura d'esercizio: -40°C +85°C Temperatura di installazione: -10°C +60°C Resistenza alla fiamma: UL94 V2 Conformità: CE, RoHS 2015/863/EU		Material: Polyamide 6.6 (Halogen Free) Working temperature: -40°C +85°C Installation temperature: -10°C +60°C Flammability resistance: UL94 V2 Compliance: CE, RoHS 2015/863/EU			
Fissaggio con adesivo Fixing with adhesive		Fissaggio con vite Fixing with screw		Fissaggio con vite Fixing with screw	
Neutro Neutral	Nero Black	Neutro Neutral	Nero Black	Neutro Neutral	Nero Black
FSA1919	FSA1919N	FSV1595	FSV1595N	FS0825	FS0825N
A = 20 mm B = 20 mm C = 5 mm D = 7 mm		A = 15 mm B = 10 mm C = 7 mm D = 3 mm E = 6 mm F = 5 mm		A = 20 mm B = 12 mm C = 13 mm D = 5 mm	
Per fascette larghezza max 5 mm For cable ties width max 5 mm		Per fascette larghezza max 4,8 mm For cable ties width max 4,8 mm		Per fascette larghezza 3,6 mm For cable ties width 3,6 mm	
FSA2727	FSA2727N	FSV2216	FSV2216N		
A = 30 mm B = 30 mm C = 7 mm D = 9 mm		A = 20 mm B = 16 mm C = 9 mm D = 6 mm E = 9 mm F = 10 mm			
Per fascette larghezza max 7 mm For cable ties width max 7 mm		Per fascette larghezza max 8,8 mm For cable ties width max 8,8 mm			

Utensile per la trazione delle fascette Tool for pulling the cable ties

Materiale: Acciaio Finitura: Verniciata a caldo Colore: Rosso Per fascette: Standard e doppia testa Conformità: CE, RoHS 2015/863/EU Material: Steel Finish: Hot painted Colour: Red For cable ties: Standard and double head Compliance: CE, RoHS 2015/863/EU			
Articolo Item	Descrizione Description		
FUP95	Utensile per la trazione ed il taglio di fascette con larghezza da 2,5 mm a 9 mm Tool for pulling and cutting cable ties with a width from 2.5 mm to 9 mm		

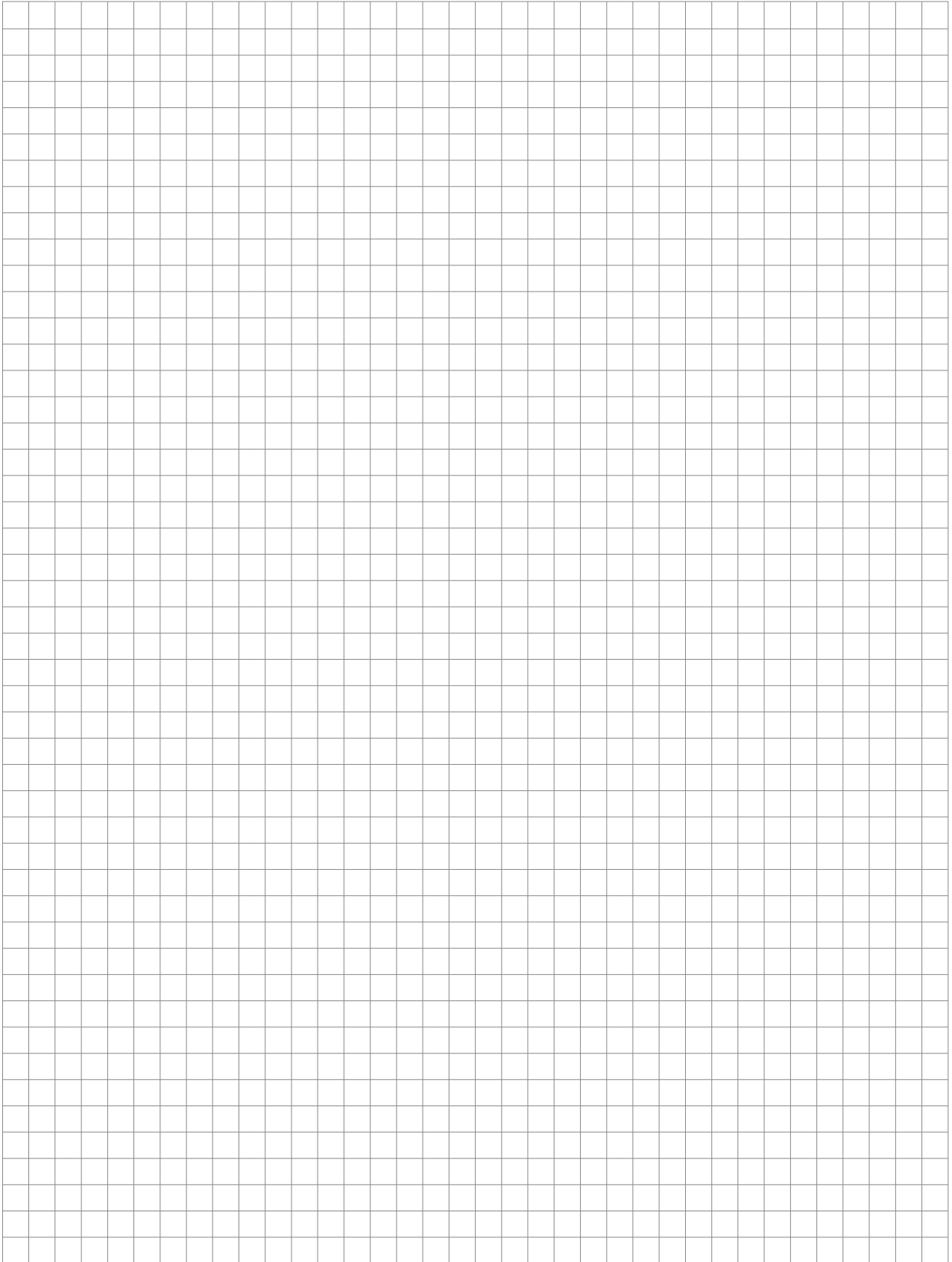



Via G. Di Vittorio, 34/36
50067 - Rignano sull'Arno
Firenze - Italia
Telefono +39 055 8349181
Telefax +39 055 8349185
Sito: www.arnocanali.it
E-mail: info@arnocanali.it



arnocanali
per portare energia

Via G. Di Vittorio, 34/36
50067 - Rignano sull'Arno
Firenze - Italia
Telefono +39 055 8349181
Telefax +39 055 8349185
Sito: www.arnocanali.it
E-mail: info@arnocanali.it